



GAS P/M Series

Modulating Gas Burners

GAS 3 P/M	80/130	÷	350	kW
GAS 4 P/M	120/180	÷	470	kW
GAS 5 P/M	155/320	÷	660	kW
GAS 6 P/M	300/520	÷	1050	kW
GAS 7 P/M	400/800	÷	1760	kW
GAS 8 P/M	640/1163	÷	2210	kW
GAS 9 P/M	870/1744	÷	3488	kW
GAS 10 P/M	1140/2441	÷	4885	kW



The GAS P/M series covers a firing range from 130 to 4885 kW.

Operation is featured by progressive two stage operation or full modulation, with an advanced modulating control system and probes.

The burners of GAS P/M series are well suited for applications requiring versatility of control (process, steam, refrigerating absorption) where a variable output is needed.

Due to their metal sheet structures, they are specifically suitable for process applications where plastic materials could be easily damaged or deformed.

Simplified maintenance is achieved by sliding bars which permit the access to the combustion head without need of removing the burner from the boiler.

Technical Data

MODEL		GAS 3 P/M	GAS 4 P/M	GAS 5 P/M	GAS 6 P/M	GAS 7 P/M
Burner operation mode		Modulating (with regulator and probes accessories) or Two stage progressive				
Modulation ratio at max. output		4 ÷ 1				
Servomotor	type	SQM 10				
	run time	5				
Heat output	kW	80/130÷350	120/180÷470	155/320÷660	300/520÷1050	400/800÷1760
	Mcal/h	69/112÷301	104/155÷404	133/275÷568	258/447÷903	344/668÷1514
Working temperature	°C min./max.	0/40				
FUEL/AIR DATA						
Net calorific value G20 gas	kWh/Nm ³	10				
G20 density gas	kg/Nm ³	0.71				
G20 gas delivery	Nm ³ /h	8/13÷35	12/18÷47	15.5/32÷66	30/52÷105	40/80÷176
Net calorific value G25 gas	kWh/Nm ³	8.6				
G25 density gas	kg/Nm ³	0.78				
G25 delivery gas	Nm ³ /h	9.3/15.1÷40.7	13.9/20.9÷54.6	18/37.2÷76.7	34.8/60.4÷122	46.5/92.9÷204.4
Net calorific value LPG gas	kWh/Nm ³	29.2				
LPG gas density	kg/Nm ³	2.16				
LPG gas delivery	Nm ³ /h	2.7/4.5÷12	4.1/6.2÷16.1	5.3/11÷22.6	10.3/17.8÷36	13.7/27.4÷60.3
Fan	type	Centrifugal with forward curve blades				
Air temperature	Max. °C	60				
ELECTRICAL DATA						
Electrical supply	Ph/Hz/V	1/50/230~(±10%)		3N/50/400-230~(±10%)		
Auxiliary electrical supply	Ph/Hz/V	1/50/230~(±10%)				
Control box	type	LANDIS LFL 1.333				
Total electrical power	kW	0.4	0.54	0.85	1.7	3.4
Auxiliary electrical power	kW	0.15	0.17	0.1	0.2	0.4
Protection level	IP	40				
Motor electrical power	kW	0.25	0.37	0.75	1.5	3
Rated motor current	A	1.8	2.9	2.85±1.65	5.9±3.4	8±13.5
Motor start current	A	4.8	9.5	10±6	22.5±13	51±86
Motor protection level	IP	44				
Ignition transformer	V1 - V2	230V - 1x8 kV				
	I1 - I2	1.8A - 30 mA				
Operation		Intermittent (at least one stop every 24 h) - Continuous (at least one stop every 72 h)				
EMISSIONS						
Sound pressure	dBA	74.6	78	83.7	83.7	84.8
Sound power	W	--				
CO Emission	mg/kWh	< 60				
NOx Emission	mg/kWh	< 120				
APPROVAL						
Directive		2006/42/EC - 2009/142/EC - 2014/30/UE - 2014/35/UE				
Conforming to		EN 676				
Certification		CE 0085AQ0710				

Reference conditions:

Temperature: 20°C - Pressure: 1013,5 mbar - Altitude: 0 m a.s.l. - Noise measured at a distance of 1 meter.

Since the Company is constantly engaged in the production improvement, the aesthetic and dimensional features, the technical data, the equipment and the accessories can be changed. This document contains confidential and proprietary information of RIELLO S.p.A. Unless authorised, this information shall not be divulged, nor duplicated in whole or in part.

MODEL		GAS 8 P/M	GAS 9 P/M	GAS 10 P/M
Burner operation mode		Modulating (with regulator and probes accessories) or Two stage progressive		
Modulation ratio at max. output		4 ÷ 1		
Servomotor	type	SQM 10		
	run time	5		
Heat output	kW	640/116÷2210	870/174.4÷3488	1140/244.1÷4885
	Mcal/h	550/1000÷1900	750/1500÷3000	980/2100÷4200
Working temperature	°C min./max.	0/40		
FUEL/AIR DATA				
Net calorific value G20 gas	kWh/Nm ³	10		
G20 density gas	kg/Nm ³	0.71		
G20 gas delivery	Nm ³ /h	64/116.3÷221	87/174.4÷348.8	114/244.1÷488.5
Net calorific value G25 gas	kWh/Nm ³	8.6		
G25 density gas	kg/Nm ³	0.78		
G25 delivery gas	Nm ³ /h	74.3/135÷256.7	101.1/202.6÷405.1	132.4/283.5÷567.4
Net calorific value LPG gas	kWh/Nm ³	29.2		
LPG gas density	kg/Nm ³	2.16		
LPG gas delivery	Nm ³ /h	21.9/39.9÷75.8	29.8/59.8÷119.6	39.1/83.7÷167.5
Fan	type	Centrifugal with forward curve blades		
Air temperature	Max. °C	60		
ELECTRICAL DATA				
Electrical supply	Ph/Hz/V	3N/50/400-230~(±10%)		
Auxiliary electrical supply	Ph/Hz/V	1/50/230~(±10%)		
Control box	type	LANDIS LFL 1.333		
Total electrical power	kW	5	10.5	14
Auxiliary electrical power	kW	1	1.5	2
Protection level	IP	40		
Motor electrical power	kW	4	9	12
Rated motor current	A	9.5	17.5÷30	26÷45
Motor start current	A	48÷83	113÷195	151÷261
Motor protection level	IP	55		
Ignition transformer	V1 - V2	230V - 1x8 kV		
	I1 - I2	1.8A - 30 mA		
Operation		Intermittent (at least one stop every 24 h) - Continuous (at least one stop every 72 h)		
EMISSIONS				
Sound pressure	dBA	85.9	89.47908	83
Sound power	W	--		
CO Emission	mg/kWh	< 60		
NOx Emission	mg/kWh	< 120		
APPROVAL				
Directive		2006/42/EC - 2009/142/EC - 2014/30/UE - 2014/35/UE		
Conforming to		EN 676		
Certification		CE 0085AP0941	CE 0085AP0942	CE 0085AP0943

Reference conditions:

Temperature: 20°C - Pressure: 1013,5 mbar - Altitude: 0 m a.s.l. - Noise measured at a distance of 1 meter.

Since the Company is constantly engaged in the production improvement, the aesthetic and dimensional features, the technical data, the equipment and the accessories can be changed. This document contains confidential and proprietary information of RIELLO S.p.A. Unless authorised, this information shall not be divulged, nor duplicated in whole or in part.

Firing Rates

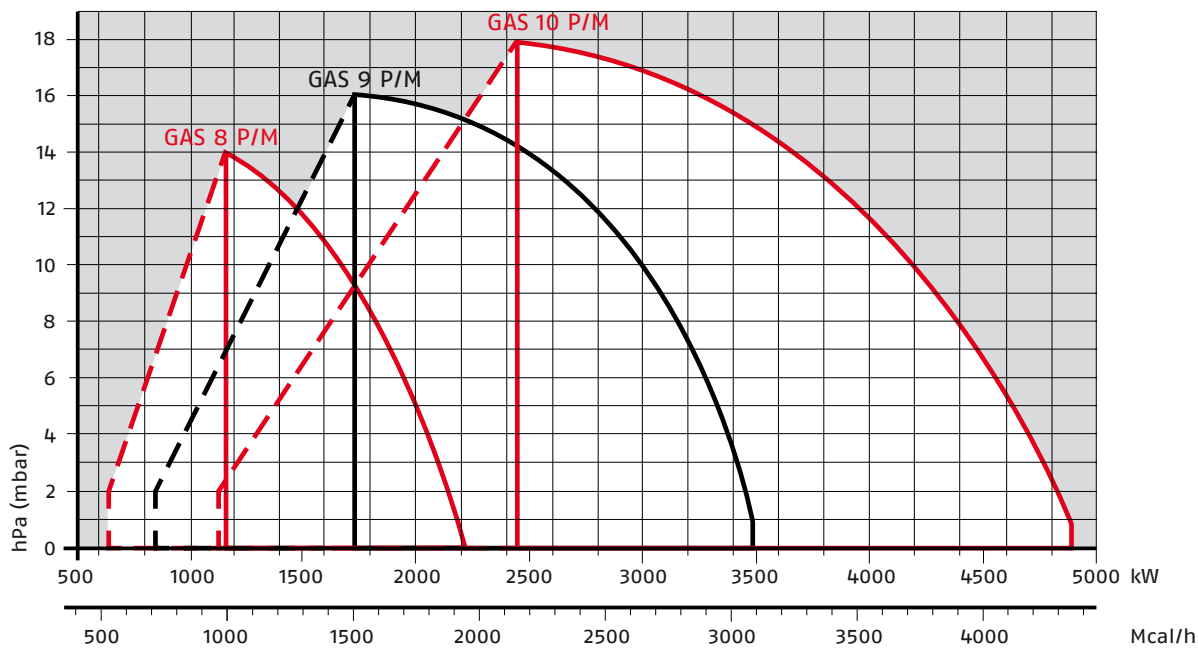
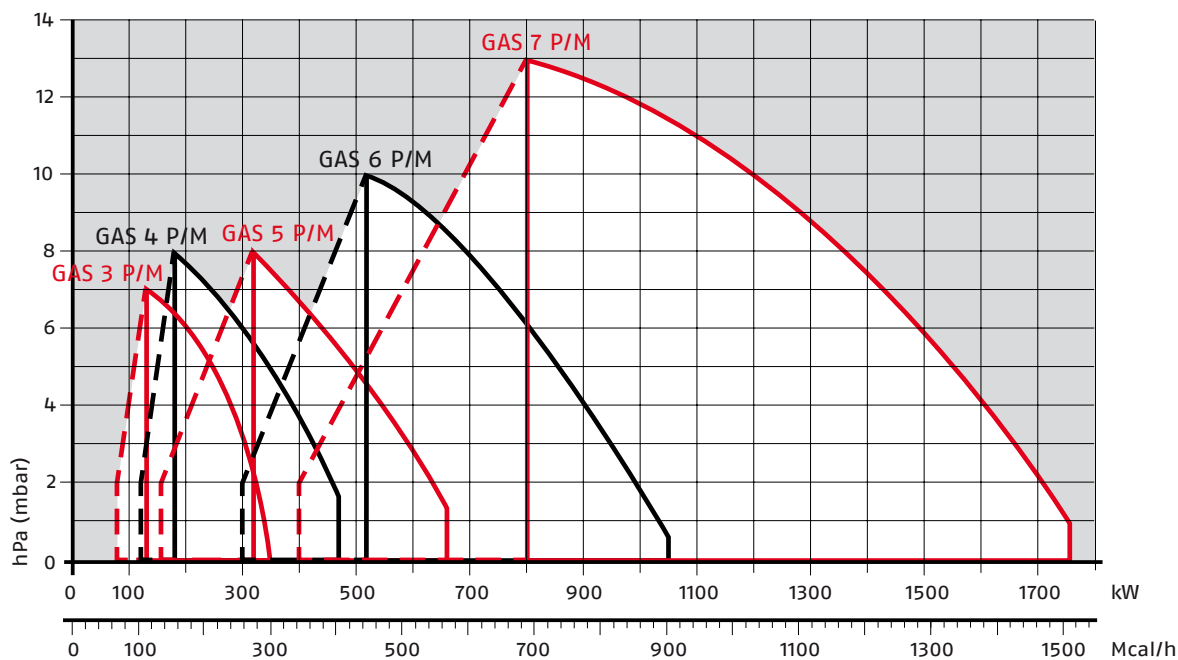

Useful firing rate for choosing the burner

Test conditions conforming to EN 676:

Temperature: 20°C

Pressure: 1013,5 mbar

Altitude: 0 m a.s.l.

Fuel Supply

GAS TRAIN DESIGNATION

Series:	MB
	MBC
	CB
	DMV

Size:	405	407	410	412	415	420					
						1200	1900	3100	5000		
				512	-	520	525	5065	5080	50100	50125 50150

Operation:	/1	1st stage mode opening
	/2	2nd stage mode opening

Leak detection control:	-	0
	CT	leak detection control device installed on the gas train
	CQ	equipped with pressure switch for leak detection control

Joint type:	R	threaded joint
	F	standard flange ISO

Electrical connection:	T	Terminals - Terminal strip
	SD	Domestic plug
	SM	Medium voltage plug

Standard output pressure range:	-	without pressure governor
	0	with governor and air/gas proportional pressure
	2	with governor and output pressure up to 20 mbar
	3	with governor and output pressure up to 30 mbar
	4	with governor and output pressure up to 40 mbar
	5	with governor and output pressure up to 50 mbar
	6	with governor and output pressure up to 60 mbar
	8	with governor and output pressure up to 80 mbar
	15	with governor and output pressure up to 150 mbar

Valve control:	0	shared
	2	separate

MBC	1200	/1	CT	R	SM	6	0
BASIC DESIGNATION				EXTENDED DESIGNATION			

GAS TRAINS

The burners are fitted with a butterfly valve to regulate the fuel, controlled by a variable profile cam servomotor.

Fuel can be supplied either from the right or left hand sides, on the basis of the application requirements. A maximum gas pressure switch stops the burner in case of an excess of pressure in fuel line.

The gas train can be selected to best fit system requirements depending on the fuel output and pressure in the supply line.

The gas train can be "Multibloc" type (containing the main components in a single unit) or "Composed" type (assembly of the single components).



Example of the variable profile cam on GAS 3-4-5-6-7 P/M burners.

MULTIBLOC GAS TRAIN WITHOUT SEAL CONTROL

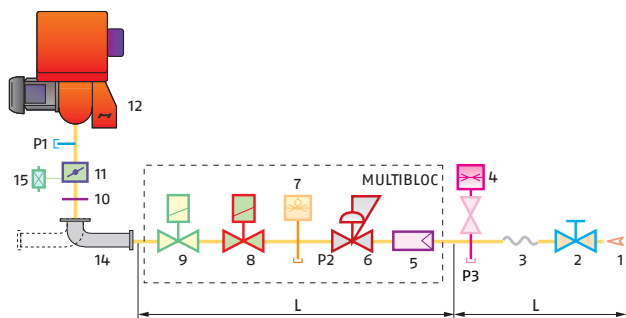

MULTIBLOC GAS TRAIN WITH SEAL CONTROL

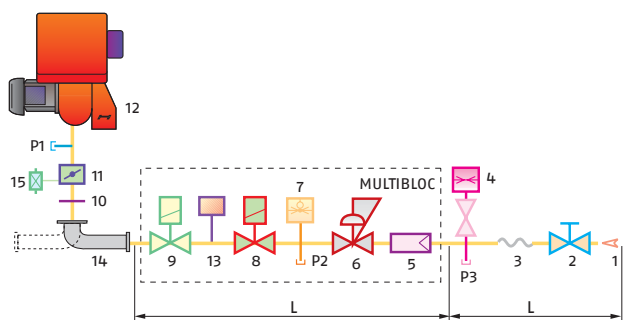

COMPOSED GAS TRAIN WITHOUT SEAL CONTROL

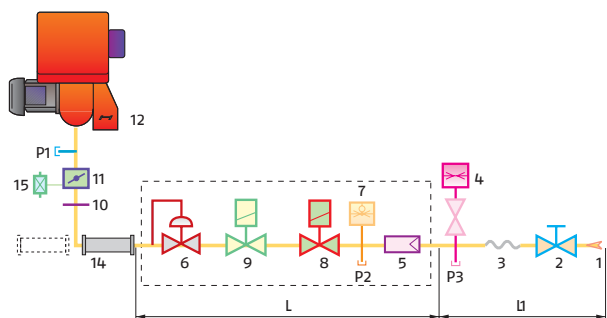

COMPOSED GAS TRAIN WITH SEAL CONTROL

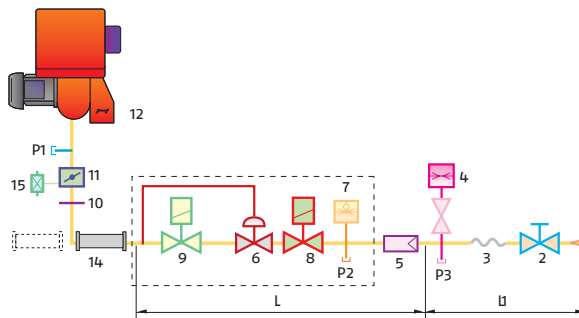

1	Gas input pipework
2	Manual valve
3	Anti-vibration joint
4	Pressure gauge with pushbutton cock
5	Filter
6	Pressure regulator (vertical)
7	Minimum gas pressure switch
8	VS safety solenoid (vertical)
9	VR regulation solenoid (vertical)
10	Gasket and flange supplied with the burner
11	Gas adjustment butterfly valve
12	Burner
13	Seal control mechanism for valves 8-9. According to standard EN 676, the seal control is compulsory for burners with maximum output above 1200 kW.
14	Gas train-burner adapter
15	Maximum gas pressure switch
P1	Combustion head pressure
P2	Pressure downstream from the regulator
P3	Pressure upstream from the filter
L	Gas train supplied separately, with the code given in the table
L1	Installer's responsibility

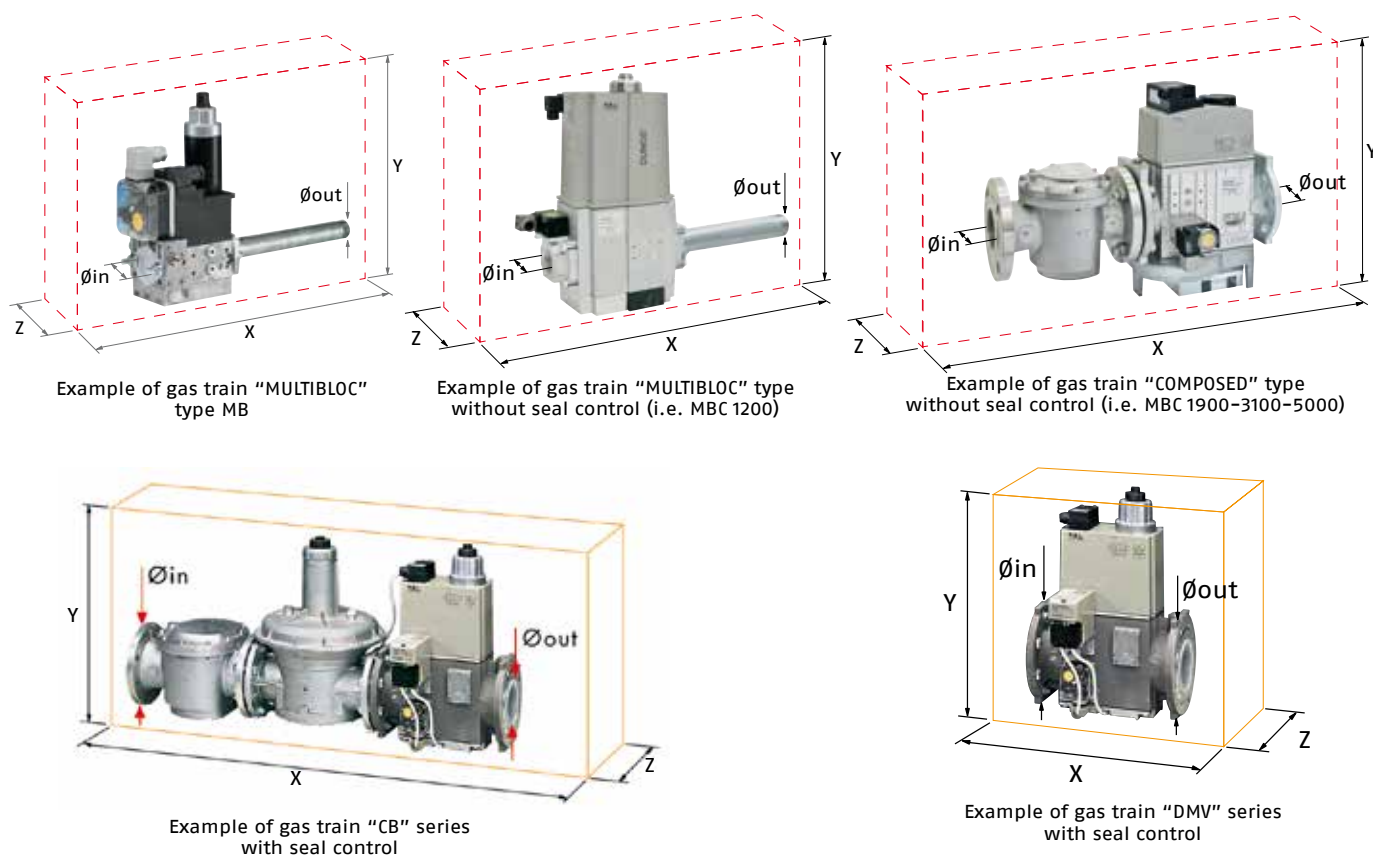

Gas trains are approved by standard EN 676 together with the burner.

The overall dimensions of the gas train depends on how they are constructed. The following table shows the maximum dimensions of the gas trains that can be fitted to the burners of GAS series, intake and outlet diameters and seal control if fitted.

Please note that the seal control can be installed as an accessory, if not already installed on the gas train. The maximum gas pressure of gas train "Multibloc" type is 360 mbar, and that one of gas train "Composed" type is 500 mbar. The range of pressure in the MULTIBLOC with flange can be modified choosing the stabiliser spring (see gas train accessory).

GAS TRAIN						
MODEL	CODE	Ø in	Ø out	X mm	Y mm	Z mm
MB 405/1 - RT 20	3970500	Rp 3/4"	Rp 3/4"	371	186	92
MB 407/1 - RT 20	3970553	Rp 3/4"	Rp 3/4"	371	196	92
MB 407/1 - RT 52	3970599	Rp 3/4"	Rp 3/4"	371	196	92
MB 407/1 - RSM 20	3970229	Rp 3/4"	Rp 3/4"	371	196	92
MB 410/1 - RT 52	3970258	Rp 1" 1/2	Rp 1" 1/2	405	217	116
MB 410/1 - RT 20	3970554	Rp 3/4"	Rp 3/4"	405	217	116
MB 410/1 - RT 52	3970600	Rp 3/4"	Rp 3/4"	405	217	116
MB 410/1 - RSM 20	3970230	Rp 3/4"	Rp 3/4"	405	221	116
MB 412/1 - RT 52	3970256	Rp 1" 1/2	Rp 1" 1/2	433	217	116
MB 412/1 - RT 20	3970144	Rp 1" 1/2	Rp 1" 1/2	433	217	116
MB 412/1 CT RT 20	3970197	Rp 1" 1/2	Rp 1" 1/2	523	217	116
MB 412/1 - RSM 20	3970231	Rp 1" 1/2	Rp 1" 1/2	433	217	116

GAS TRAIN						
MODEL	CODE	∅ in	∅ out	X mm	Y mm	Z mm
MB 415/1 - RT 30	3970180	Rp 1" 1/2	Rp 1" 1/2	523	250	100
MB 415/1 CT RT 30	3970198	Rp 1" 1/2	Rp 1" 1/2	523	250	229
MB 415/1 - RT 52	3970250	Rp 1" 1/2	Rp 1" 1/2	523	250	100
MB 415/1 CT RT 52	3970253	Rp 1" 1/2	Rp 1" 1/2	523	250	229
MB 415/1 RSM 30	3970232	Rp 1" 1/2	Rp 1" 1/2	523	250	100
MB 420/1 RT 30	3970181	Rp 2"	Rp 2"	523	300	100
MB 420/1 CT RT 30	3970182	Rp 2"	Rp 2"	523	300	229
MB 420/1 RT 52	3970257	Rp 2"	Rp 2"	523	300	100
MB 420/1 CT RT 52	3970252	Rp 2"	Rp 2"	523	300	229
MB 420/1 RSM 30	3970233	Rp 2"	Rp 2"	523	300	100
MB 420/1 CT RSM 30	3970234	Rp 2"	Rp 2"	523	300	229

GAS TRAIN						
MODEL	CODE	∅ in	∅ out	X mm	Y mm	Z mm
MBC 1200/1 - RSM 60	3970221	Rp 2"	Rp 2"	528	424	161
MBC 1200/1 CT RSM 60	3970225	Rp 2"	Rp 2"	528	424	290
MBC 1900/1 - FSM 40	3970222	DN 65	DN 65	613	430	237
MBC 1900/1 CT FSM 40	3970226	DN 65	DN 65	613	430	298
MBC 3100/1 - FSM 40	3970223	DN 80	DN 80	633	500	240
MBC 3100/1 CT FSM 40	3970227	DN 80	DN 80	633	500	319
MBC 5000/1 - FSM 80	3970224	DN 100	DN 100	733	576	280
MBC 5000/1 CT FSM 80	3970228	DN 100	DN 100	733	576	348

GAS TRAIN						
MODEL	CODE	∅ in	∅ out	X mm	Y mm	Z mm
CB 512/1 - RSM 30	3970145	Rp 1" 1/2	Rp 1" 1/2	891	261	245
CB 512/1 - CT RSM 30	20045589	Rp 1" 1/2	Rp 1" 1/2	891	261	245
CB 520/1 - RSM 30	3970146	Rp 2"	Rp 2"	986	328	255
CB 520/1 - CT RSM 30	3970160	Rp 2"	Rp 2"	986	328	255
CB 525/1 - RSM 30	20044659	Rp 2"	Rp 2"	1025	356	285
CB 525/1 - CT RSM 30	20044660	Rp 2"	Rp 2"	1025	356	285
CB 5065/1 - FSM 30	3970147	DN 65	DN 65	906	356	285
CB 5065/1 CT FSM 30	3970161	DN 65	DN 65	906	356	285
CB 5080/1 - FSM 30	3970148	DN 80	DN 80	934	416	285
CB 5080/1 CT FSM 30	3970162	DN 80	DN 80	934	416	285
CB 50100/1 - FSM 30	3970149	DN 100	DN 100	1054	501	350
CB 50100/1 CT FSM 30	3970163	DN 100	DN 100	1054	501	350
CB 50125/1 - FSM 30	20015871	DN 125	DN 125	1164	780	400
CB 50125/1 CT FSM 30	3970196	DN 125	DN 125	1164	780	400

GAS TRAIN						
MODEL	CODE	∅ in	∅ out	X mm	Y mm	Z mm
DMV 512/1 - RSM - 0	20043035	Rp 1" 1/2	Rp 1" 1/2	490	292	245
DMV 512/1 -CT RSM - 0	20043036	Rp 1" 1/2	Rp 1" 1/2	490	292	245
DMV 512/1 - CQ RSM - 2	20043037	Rp 1" 1/2	Rp 1" 1/2	490	292	245
DMV 520/1 - RSM - 0	20043038	Rp 2"	Rp 2"	490	292	255
DMV 520/1 CT RSM - 0	20043039	Rp 2"	Rp 2"	490	292	255
DMV 520/1 CQ RSM - 2	20043040	Rp 2"	Rp 2"	490	292	255
DMV 525/1 - RSM - 0	20043053	Rp 2"	Rp 2"	530	338	270
DMV 525/1 CT RSM - 0	20043054	Rp 2"	Rp 2"	530	338	270
DMV 525/1 CQ RSM - 2	20043055	Rp 2"	Rp 2"	530	338	270
DMV 5065/1 - FSM - 0	20043041	DN 65	DN 65	290	338	270
DMV 5065/1 CT FSM - 0	20043042	DN 65	DN 65	290	338	270
DMV 5065/1 CQ FSM - 2	20043043	DN 65	DN 65	290	338	270
DMV 5080/1 - FSM - 0	20043044	DN 80	DN 80	310	397	290
DMV 5080/1 CT FSM - 0	20043045	DN 80	DN 80	310	397	290
DMV 5080/1 CQ FSM - 2	20043046	DN 80	DN 80	310	397	290
DMV 50100/1 - FSM - 0	20043047	DN 100	DN 100	350	449	307
DMV 50100/1 CT FSM - 0	20043048	DN 100	DN 100	350	449	307
DMV 50100/1 CQ FSM - 2	20043049	DN 100	DN 100	350	449	307
DMV 50125/1 - FSM - 0	20043050	DN 125	DN 125	400	554	333
DMV 50125/1 CT FSM - 0	20043051	DN 125	DN 125	400	554	333
DMV 50125/1 CQ FSM - 2	20043052	DN 125	DN 125	400	554	333

Pressure Drop Diagram

The diagrams indicate the minimum pressure drop of the burners with the various gas trains that can be matched with them; at the value of these pressure drop add the combustion chamber pressure. The value thus calculated represents the minimum required input pressure to the gas train.

GAS 3 P/M (NATURAL GAS)

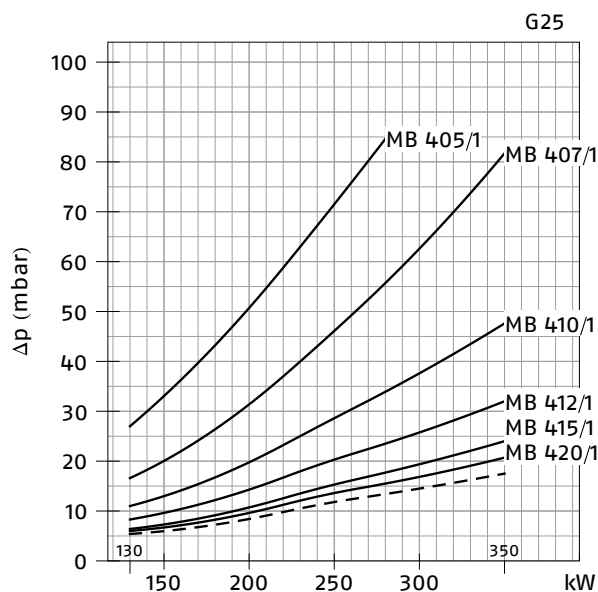
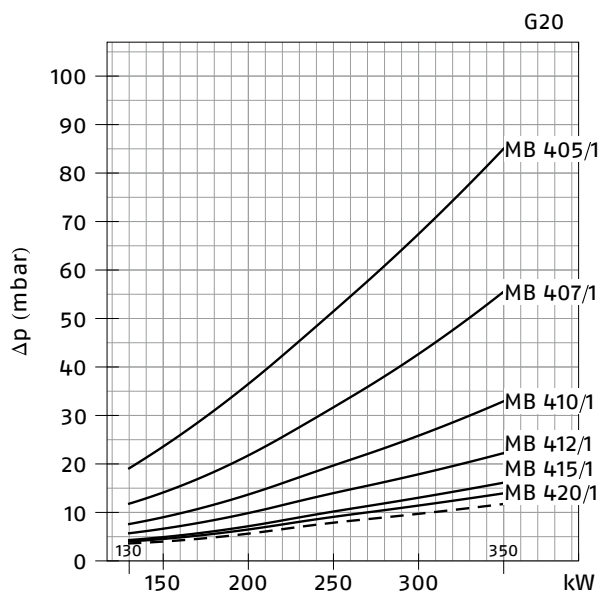

GAS 3 P/M (NATURAL GAS)

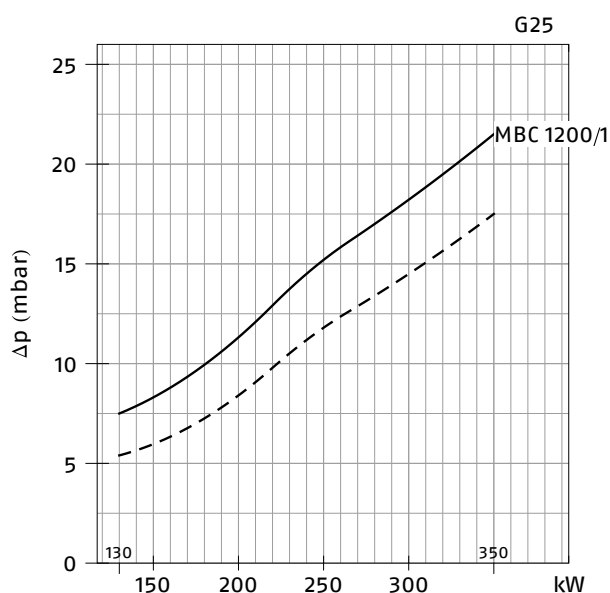
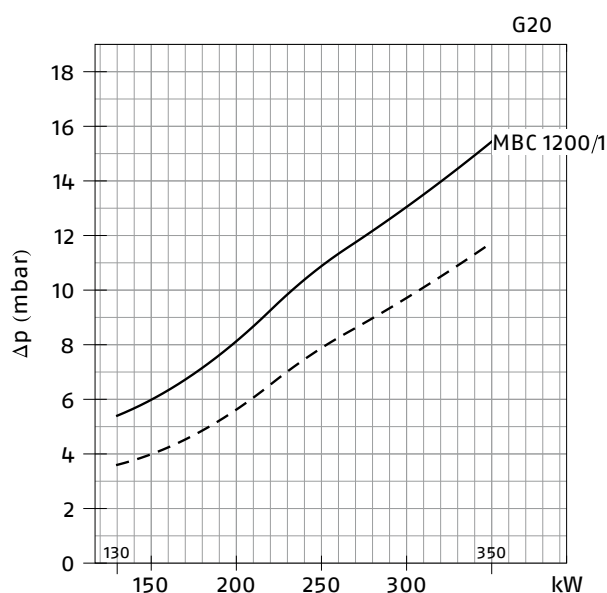

- Combustion head + gas butterfly valve + gas train
- - - Combustion head + gas butterfly valve

GAS 3 P/M (NATURAL GAS)

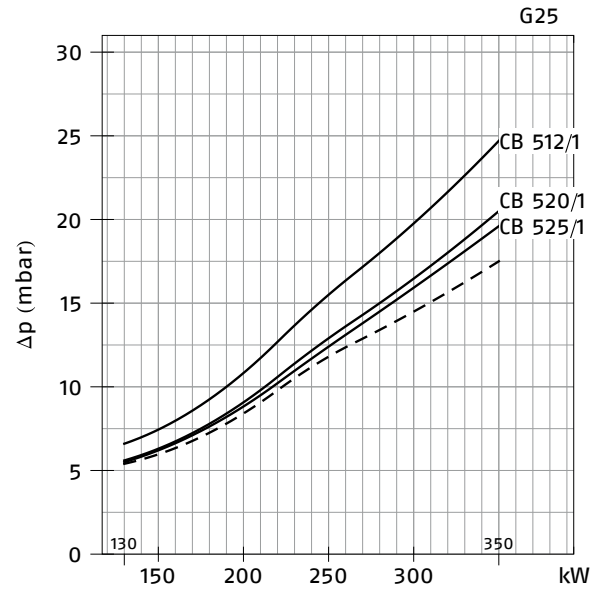
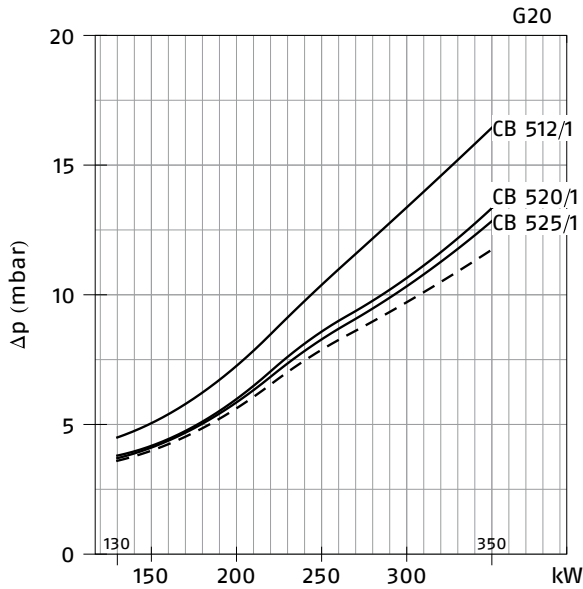

GAS 3 P/M (NATURAL GAS)

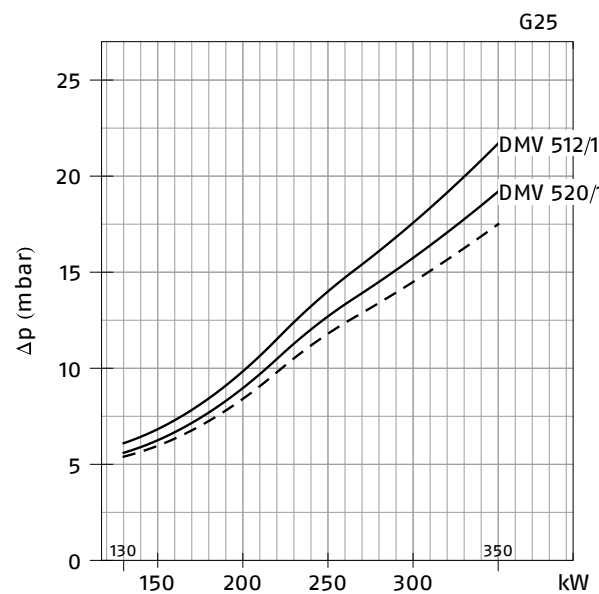
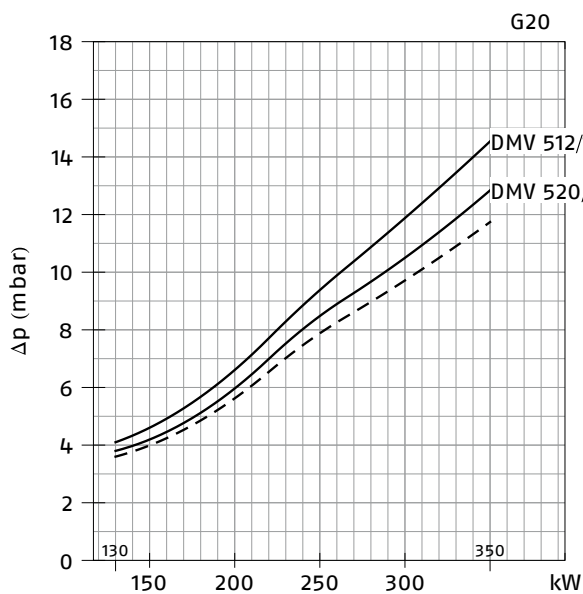

- Combustion head + gas butterfly valve + gas train
- - - Combustion head + gas butterfly valve

GAS 4 P/M (NATURAL GAS)

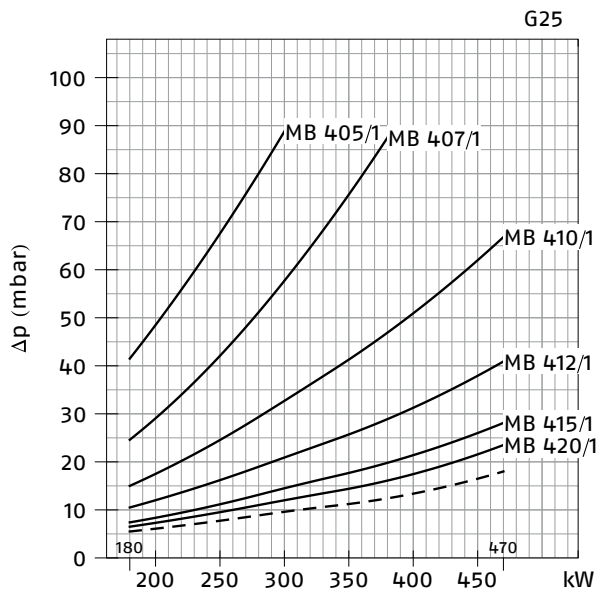
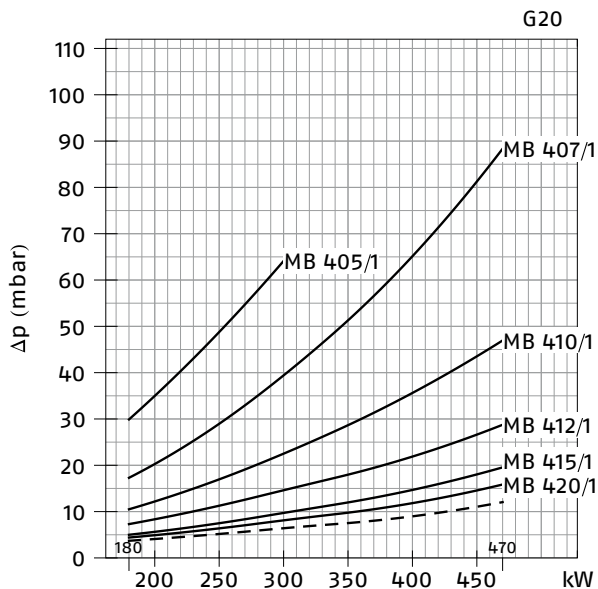

GAS 4 P/M (NATURAL GAS)

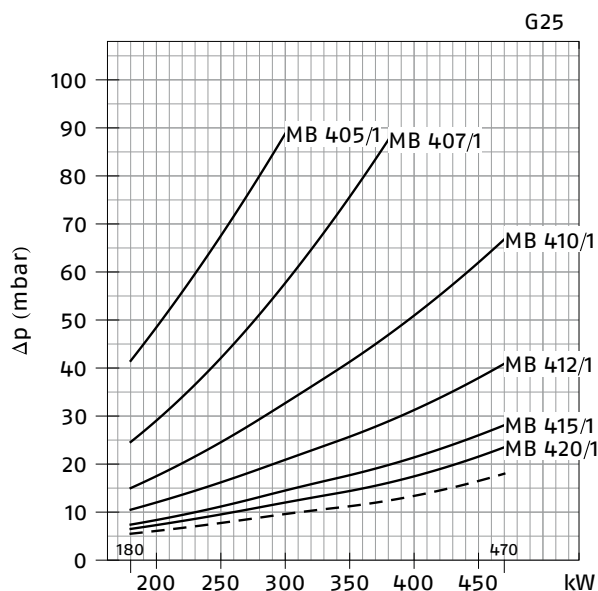
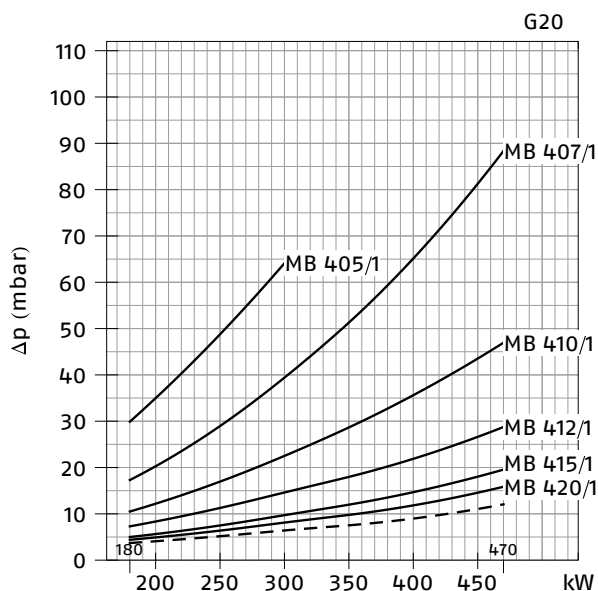

— Combustion head + gas butterfly valve + gas train
 - - - Combustion head + gas butterfly valve

GAS 4 P/M (NATURAL GAS)

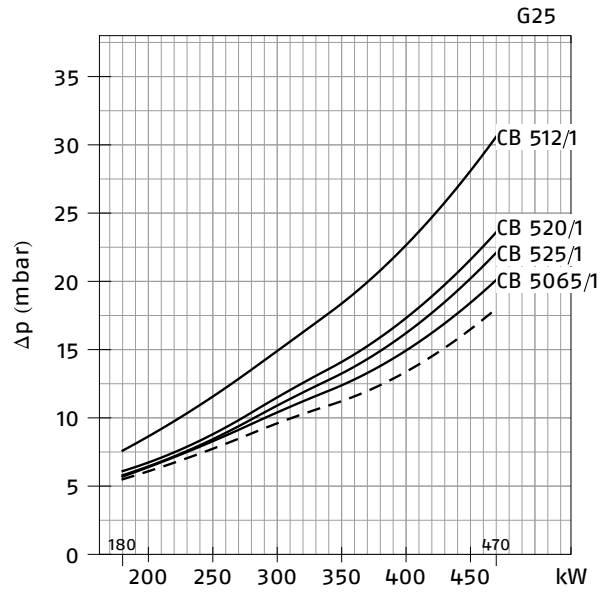
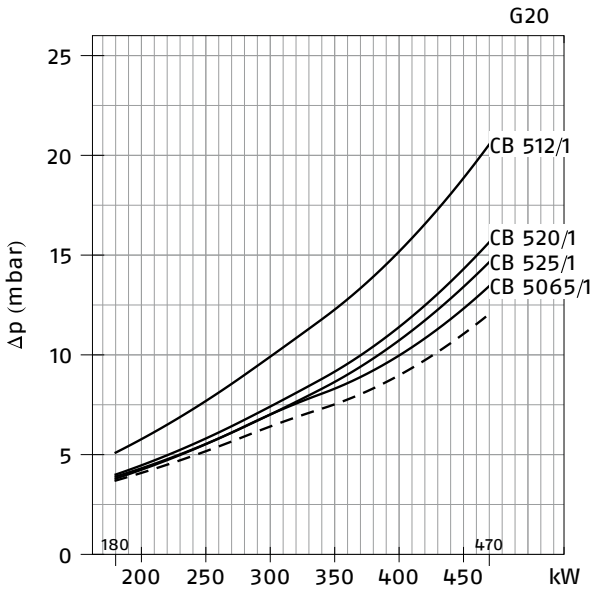

GAS 4 P/M (NATURAL GAS)

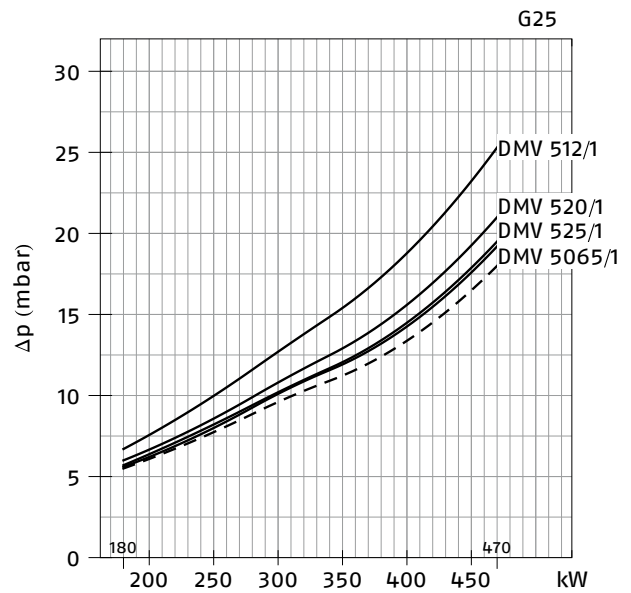
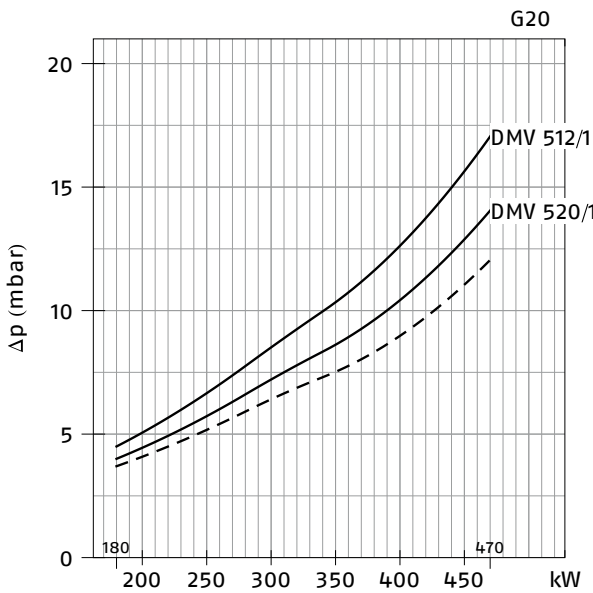

- Combustion head + gas butterfly valve + gas train
- - - Combustion head + gas butterfly valve

GAS 5 P/M (NATURAL GAS)

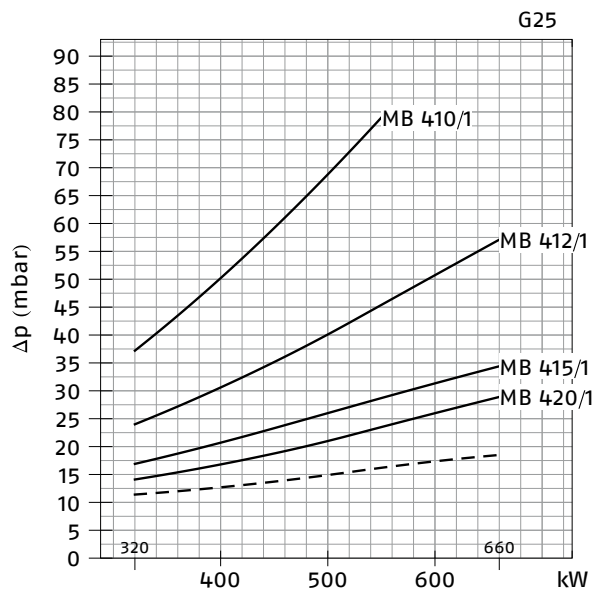
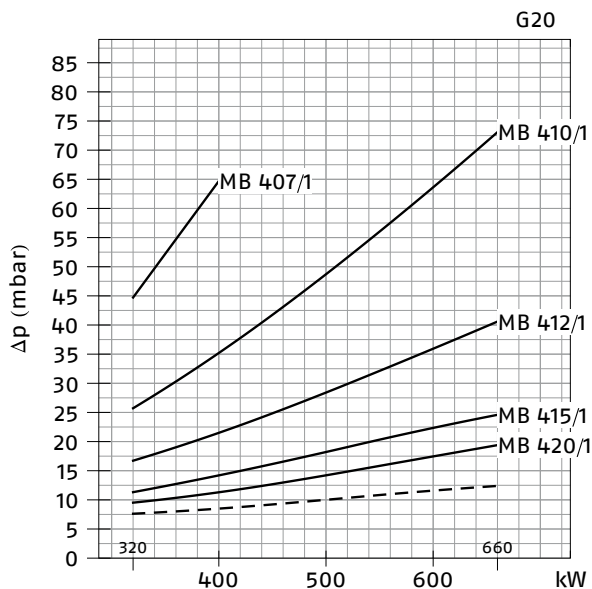

GAS 5 P/M (NATURAL GAS)

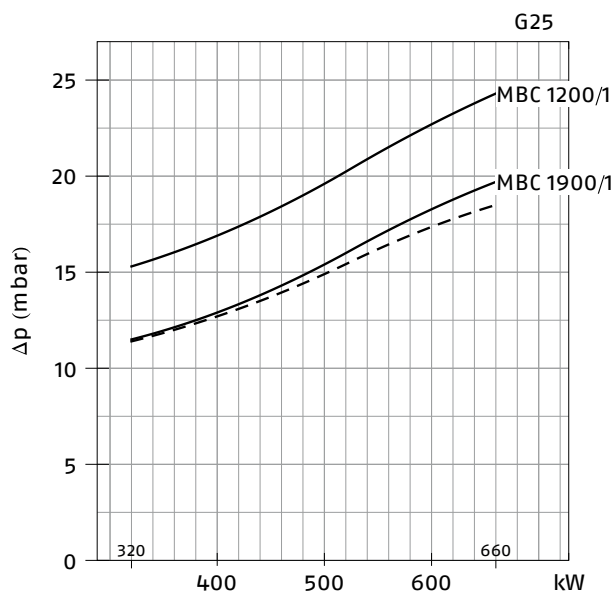
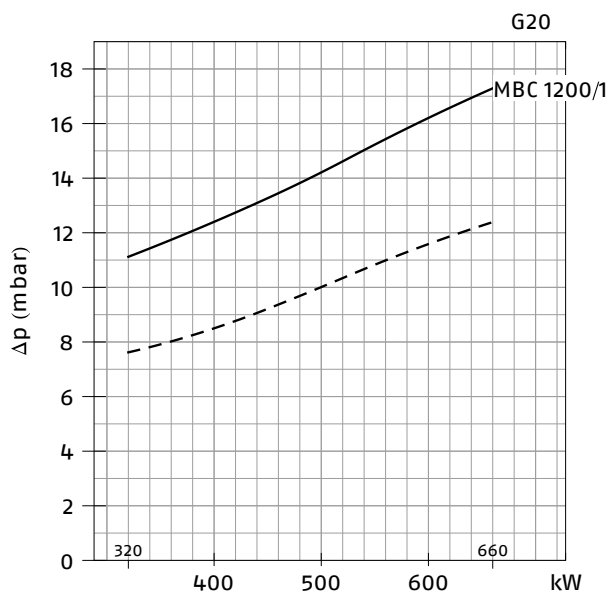

- Combustion head + gas butterfly valve + gas train
- - - Combustion head + gas butterfly valve

GAS 5 P/M (NATURAL GAS)

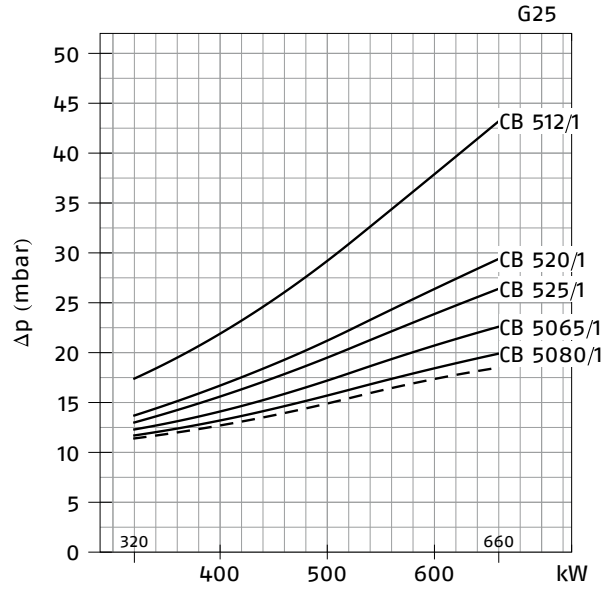
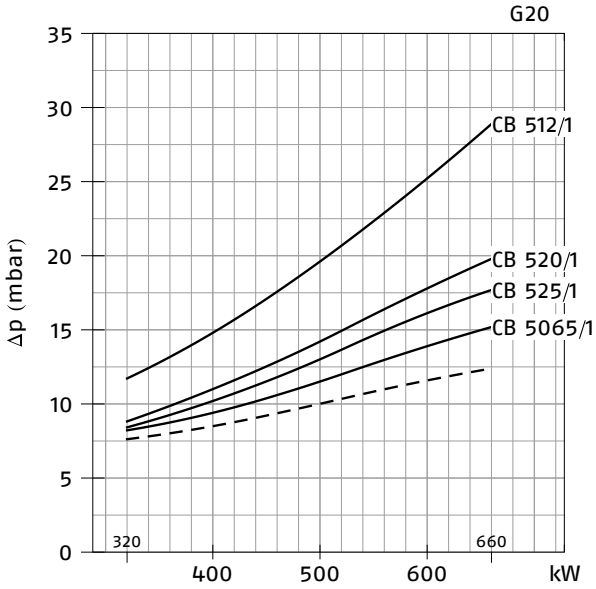

GAS 5 P/M (NATURAL GAS)

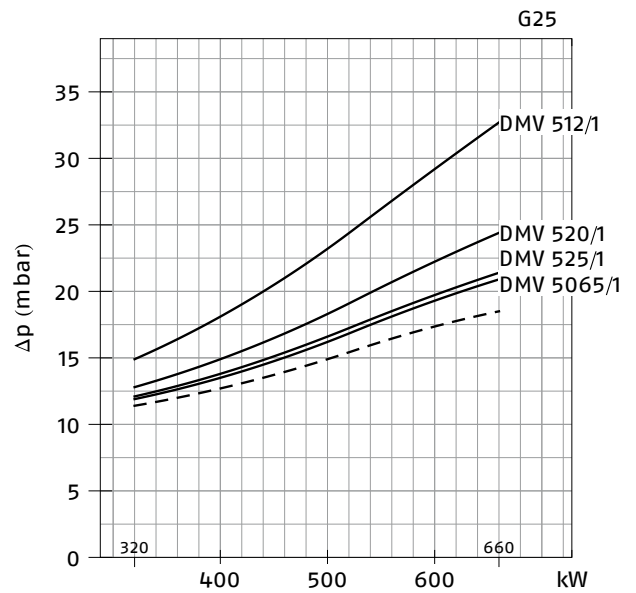
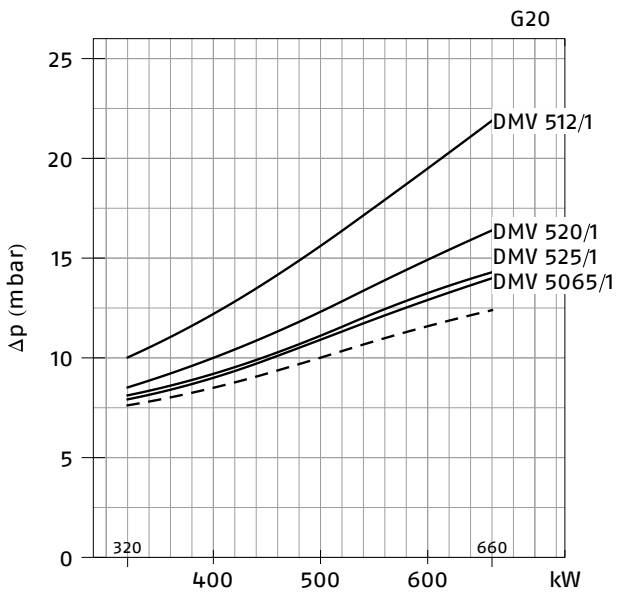

— Combustion head + gas butterfly valve + gas train
 - - - Combustion head + gas butterfly valve

GAS 6 P/M (NATURAL GAS)

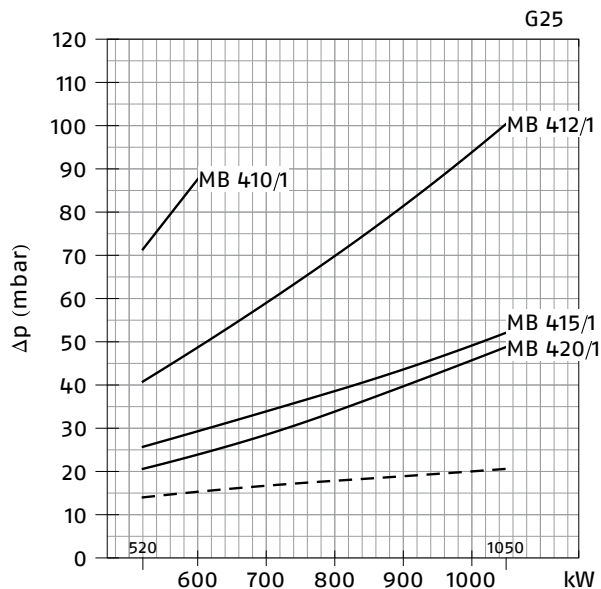
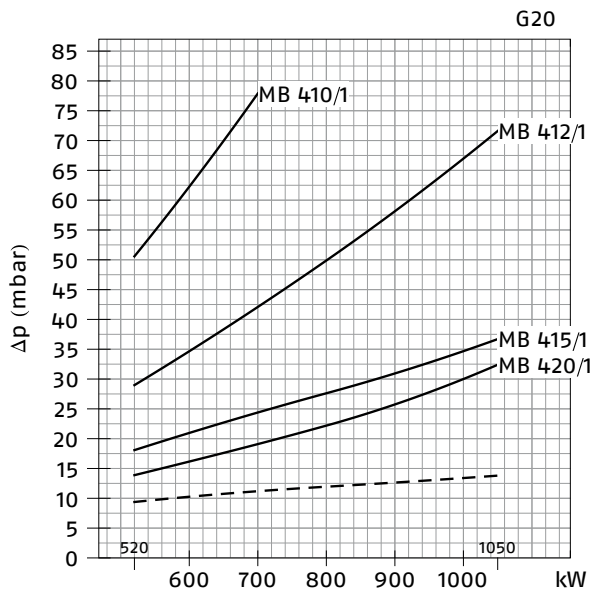

GAS 6 P/M (NATURAL GAS)

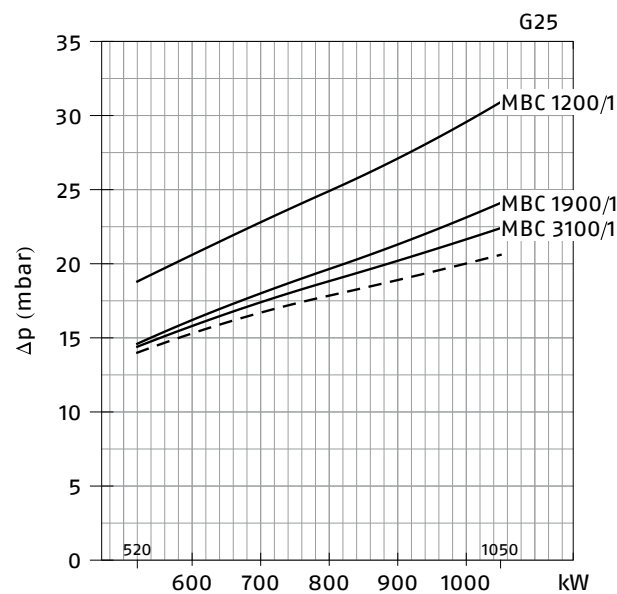
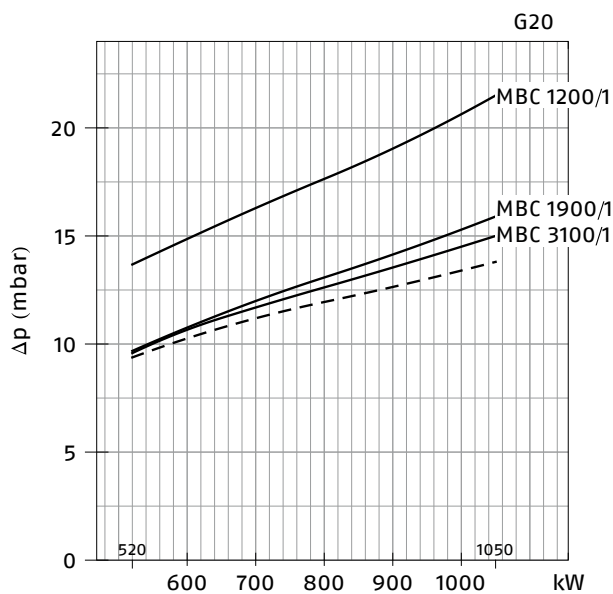

- Combustion head + gas butterfly valve + gas train
- - - Combustion head + gas butterfly valve

GAS 6 P/M (NATURAL GAS)

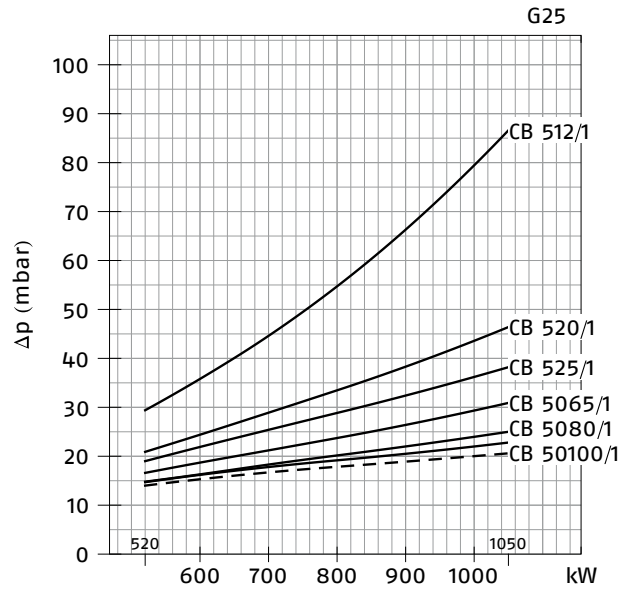
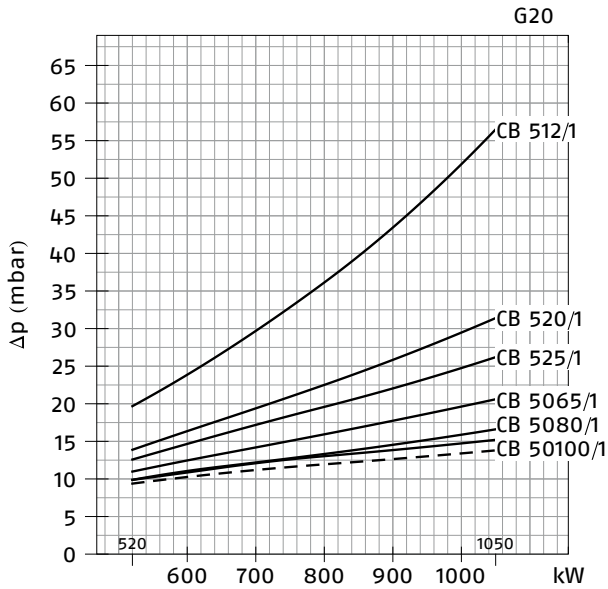

GAS 6 P/M (NATURAL GAS)

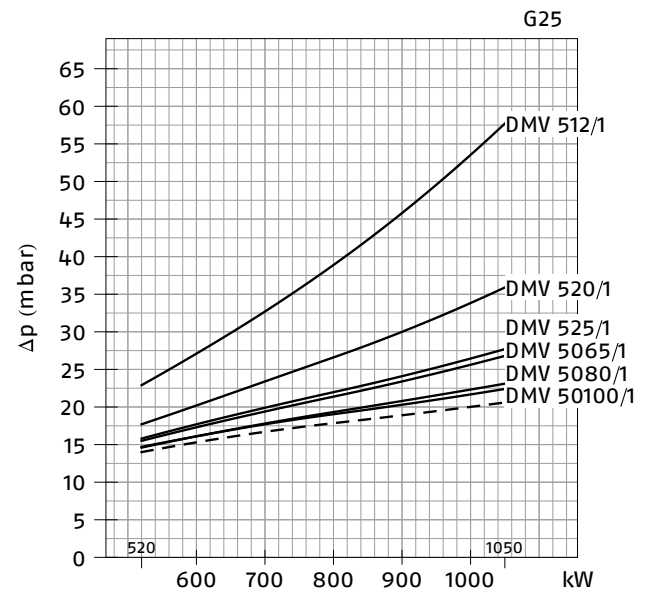
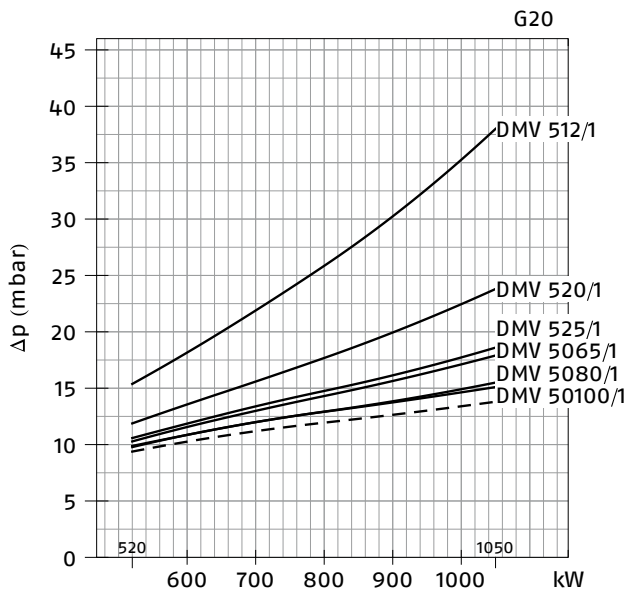

- Combustion head + gas butterfly valve + gas train
- - - Combustion head + gas butterfly valve

GAS 7 P/M (NATURAL GAS)

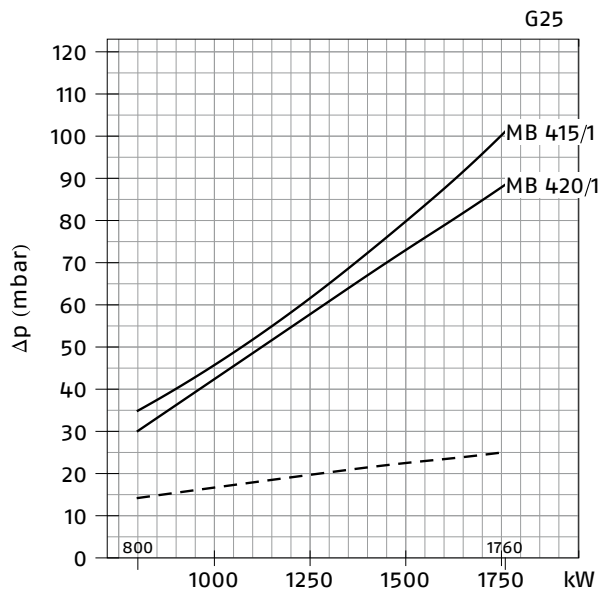
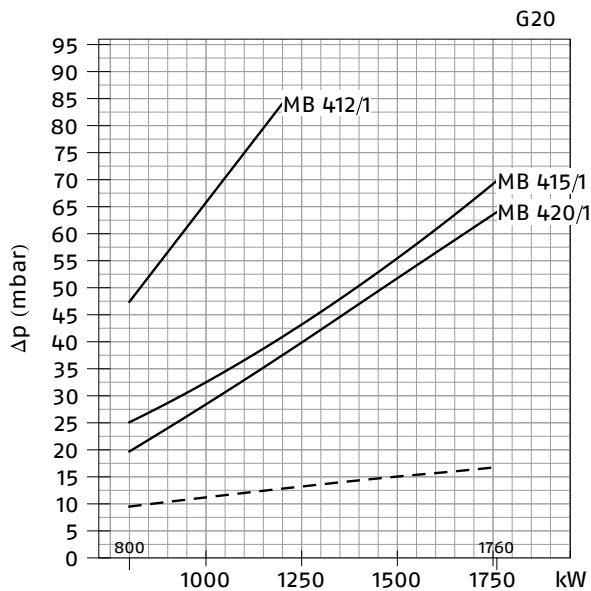

GAS 7 P/M (NATURAL GAS)

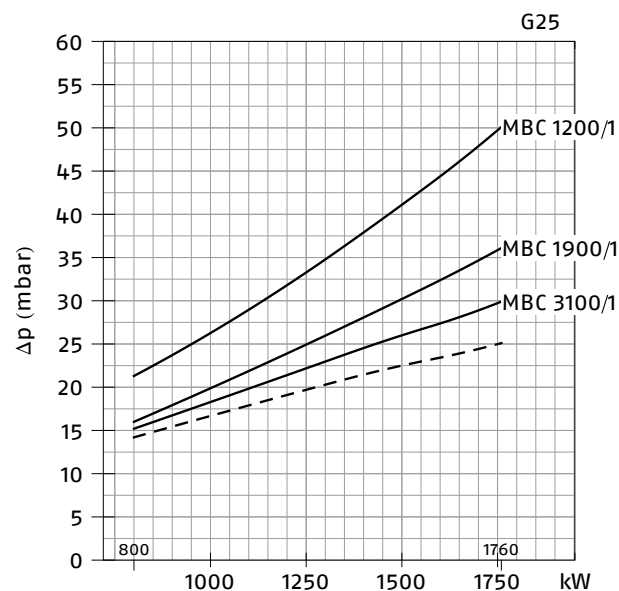
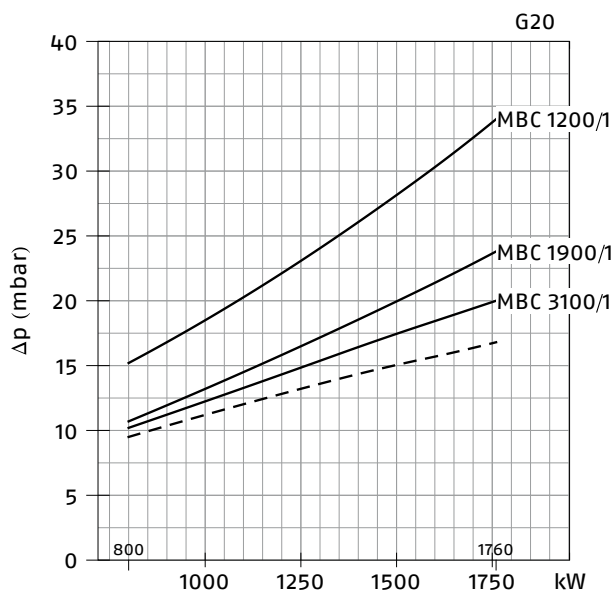

- Combustion head + gas butterfly valve + gas train
- - - Combustion head + gas butterfly valve

GAS 7 P/M (NATURAL GAS)

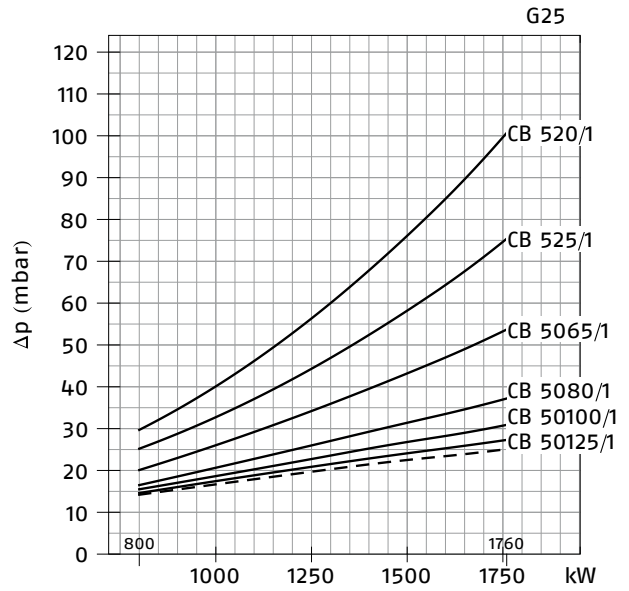
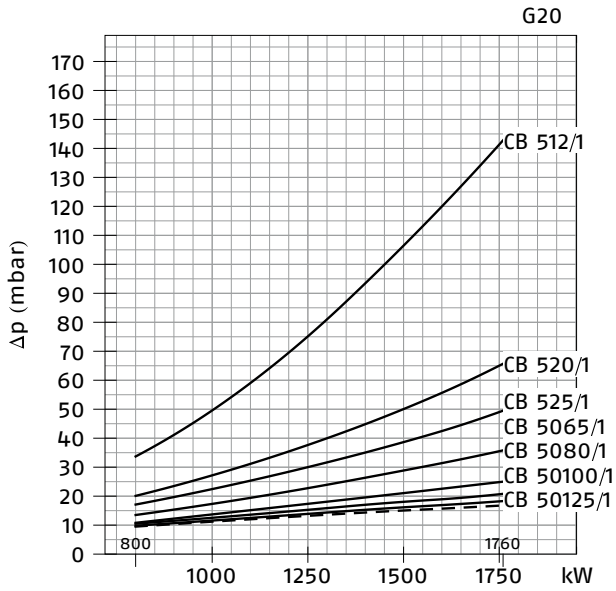

GAS 7 P/M (NATURAL GAS)

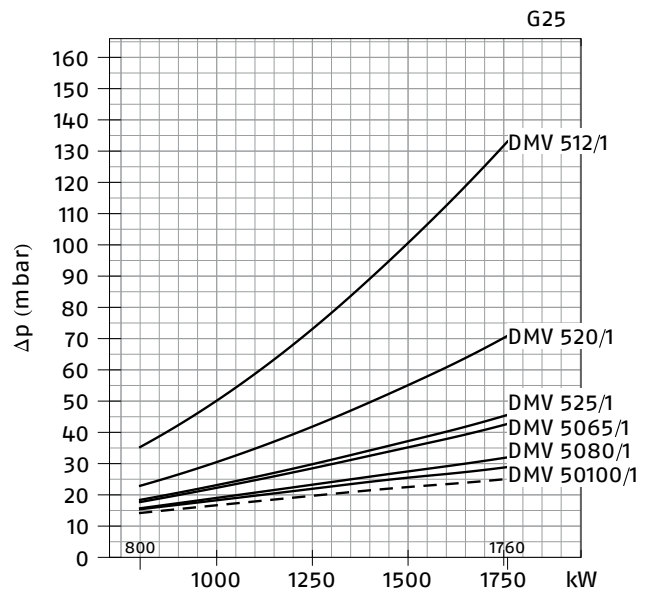
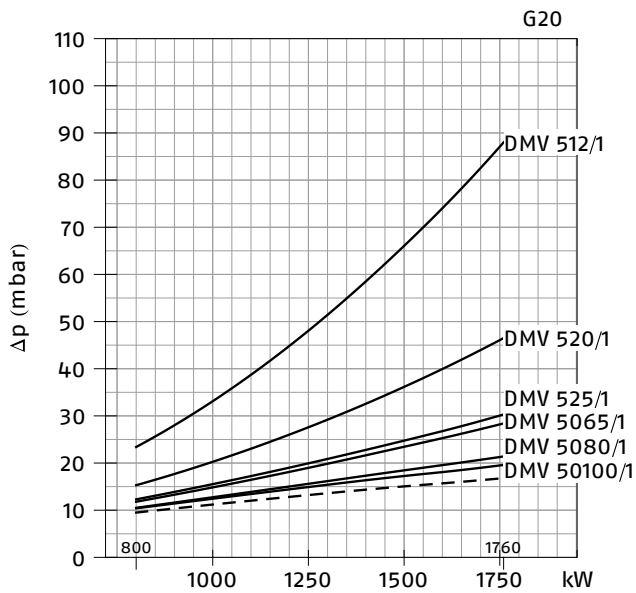

— Combustion head + gas butterfly valve + gas train
 - - - Combustion head + gas butterfly valve

GAS 8 P/M (NATURAL GAS)

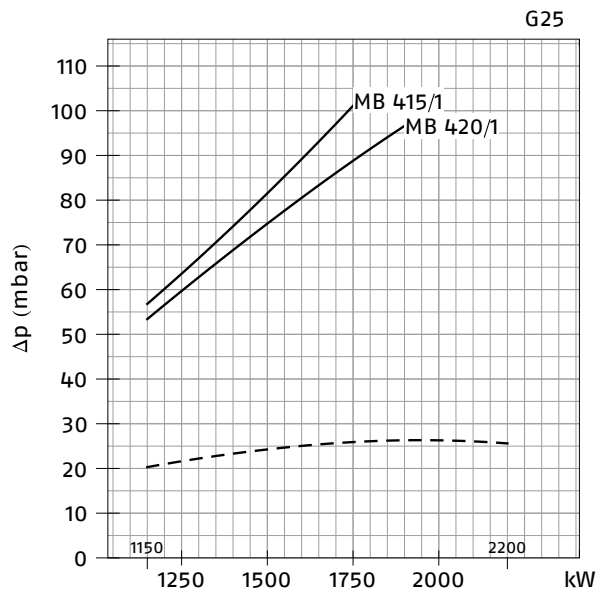
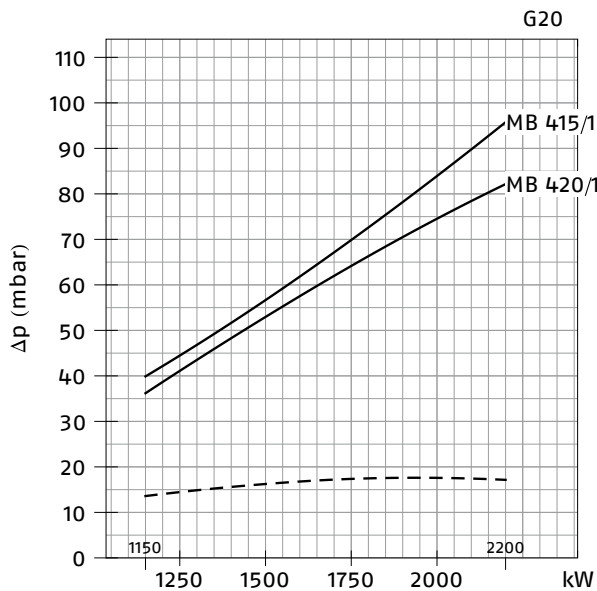

GAS 8 P/M (NATURAL GAS)

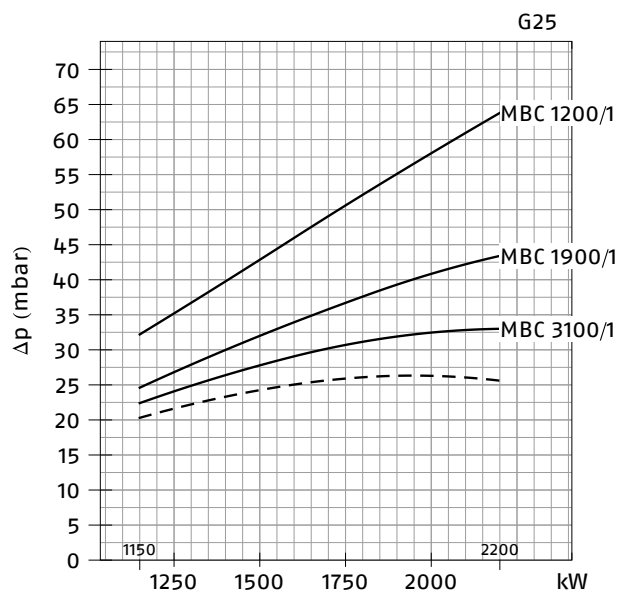
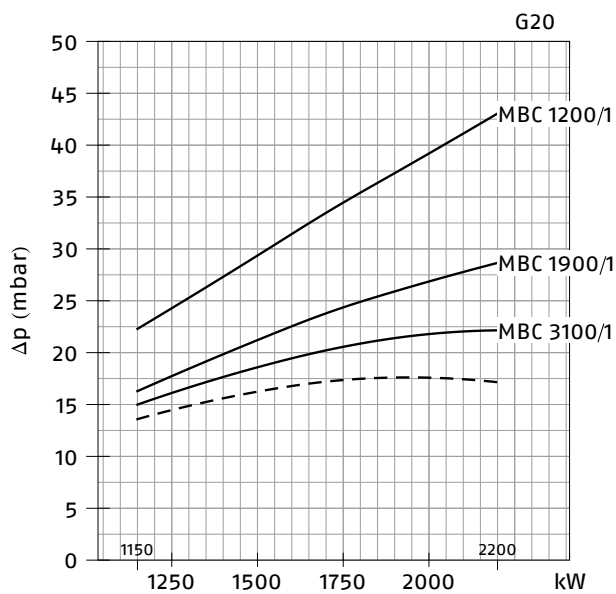

- Combustion head + gas butterfly valve + gas train
- - - Combustion head + gas butterfly valve

GAS 8 P/M (NATURAL GAS)

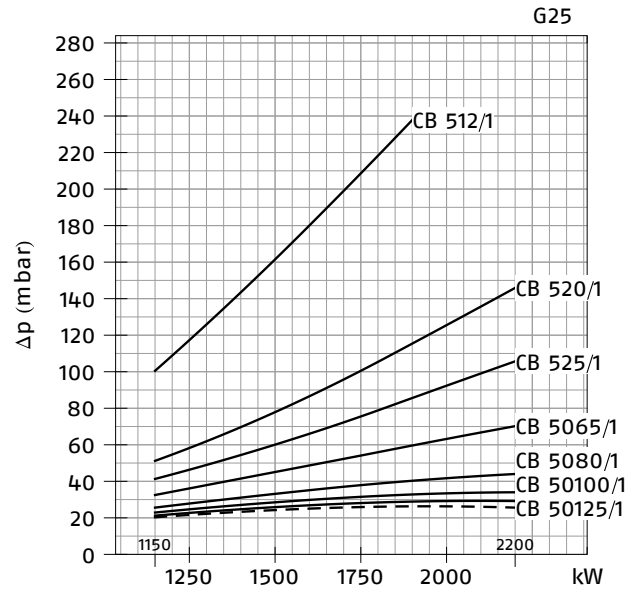
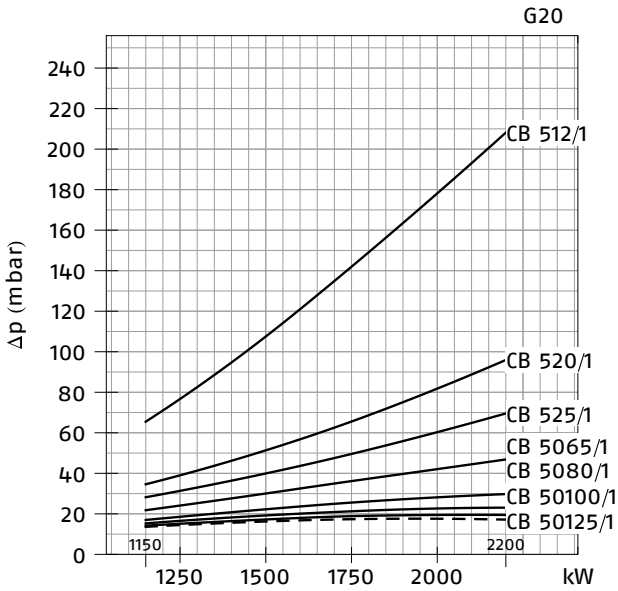

GAS 8 P/M (NATURAL GAS)

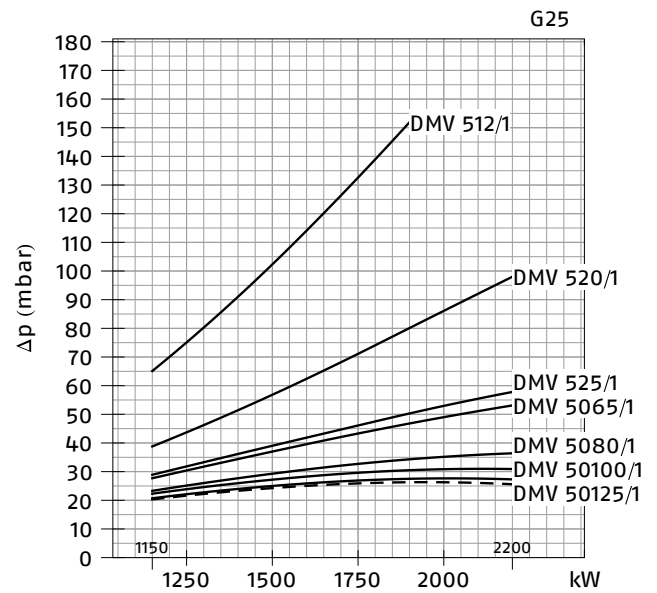
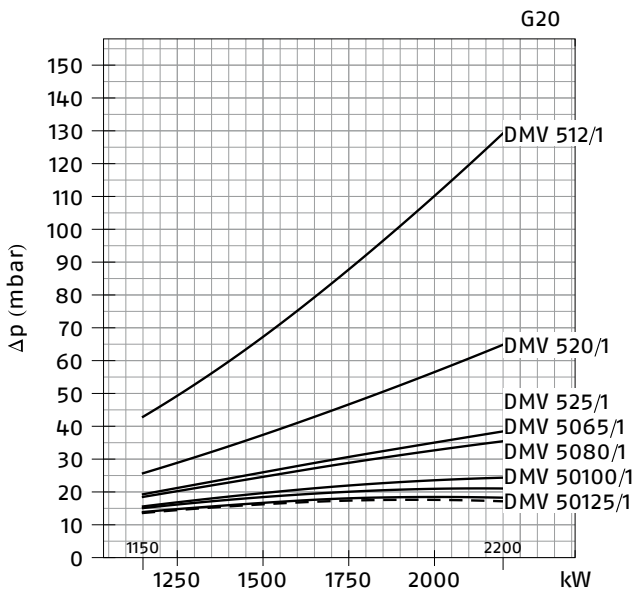

- Combustion head + gas butterfly valve + gas train
- - - Combustion head + gas butterfly valve

GAS 9 P/M (NATURAL GAS)

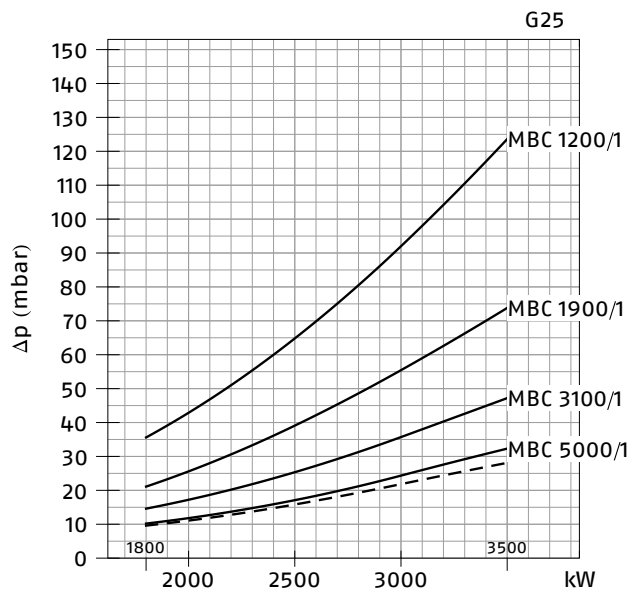
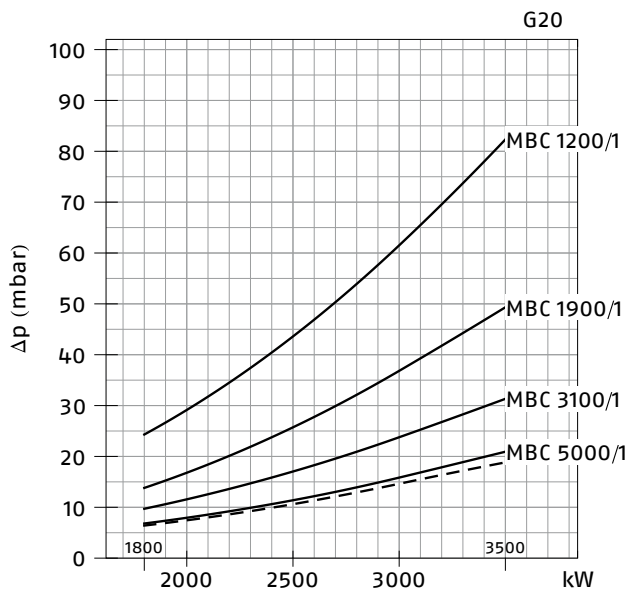

GAS 9 P/M (NATURAL GAS)

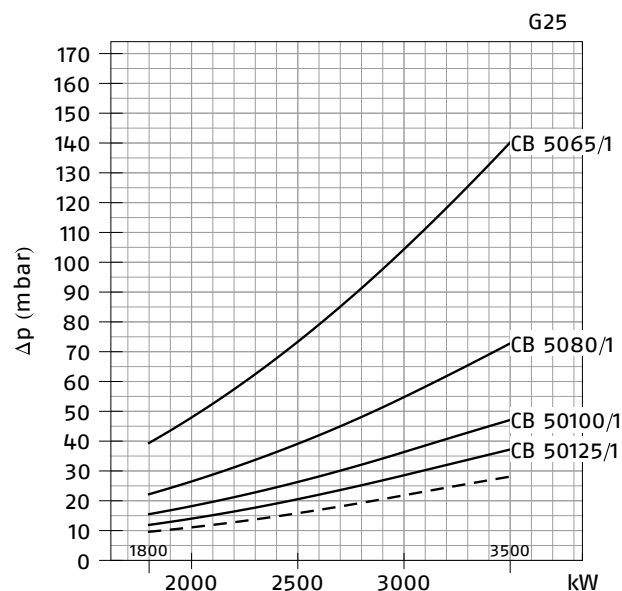
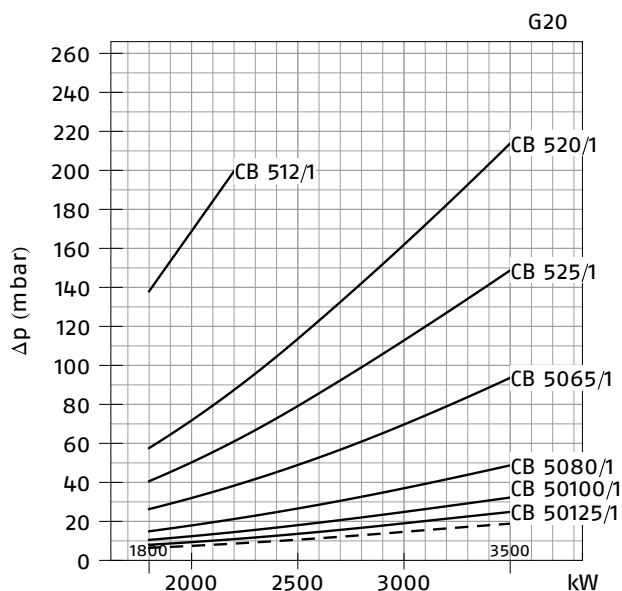

- Combustion head + gas butterfly valve + gas train
- - - Combustion head + gas butterfly valve

GAS 9 P/M (NATURAL GAS)

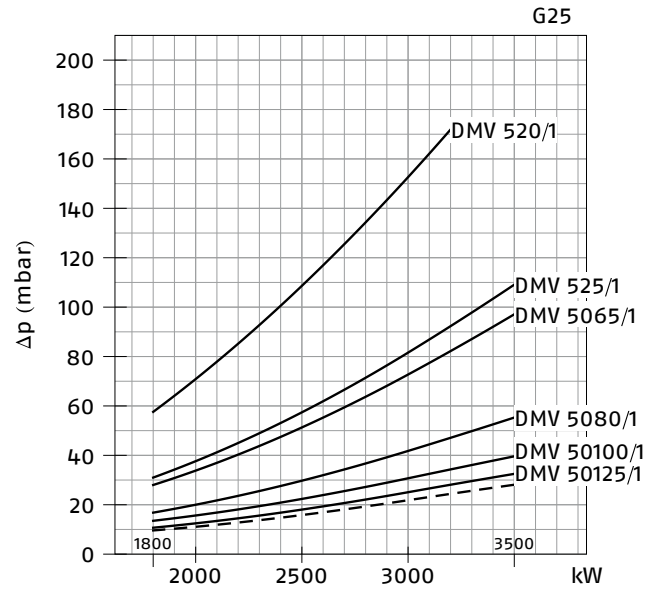
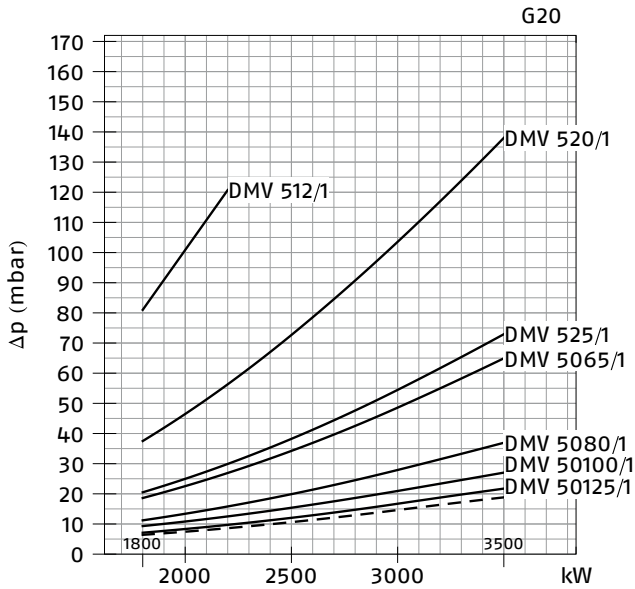

GAS 10 P/M (NATURAL GAS)

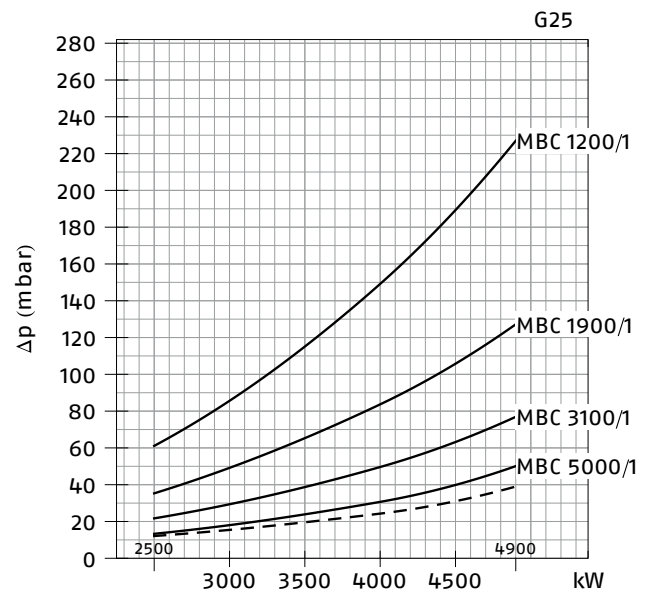
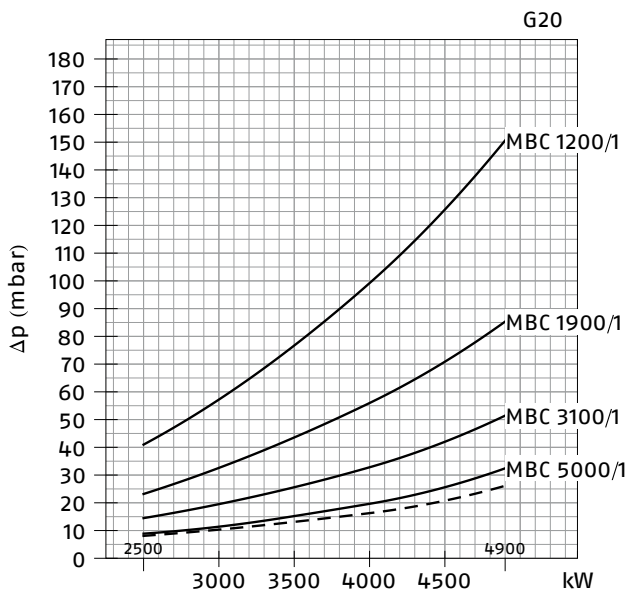

- Combustion head + gas butterfly valve + gas train
- - - Combustion head + gas butterfly valve

GAS 10 P/M (NATURAL GAS)

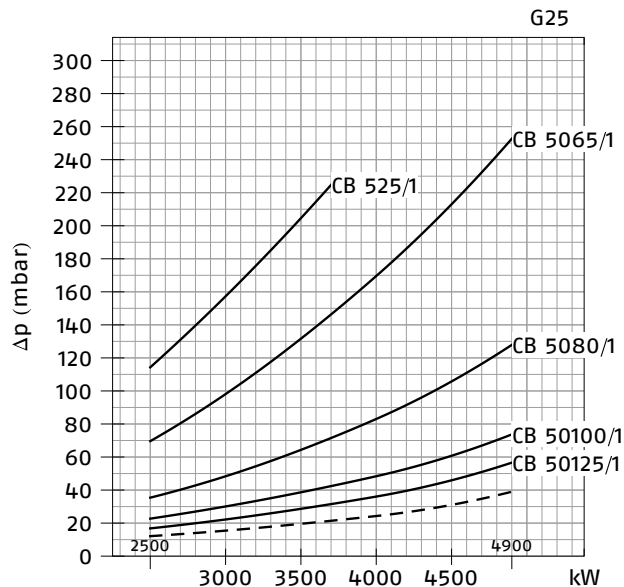
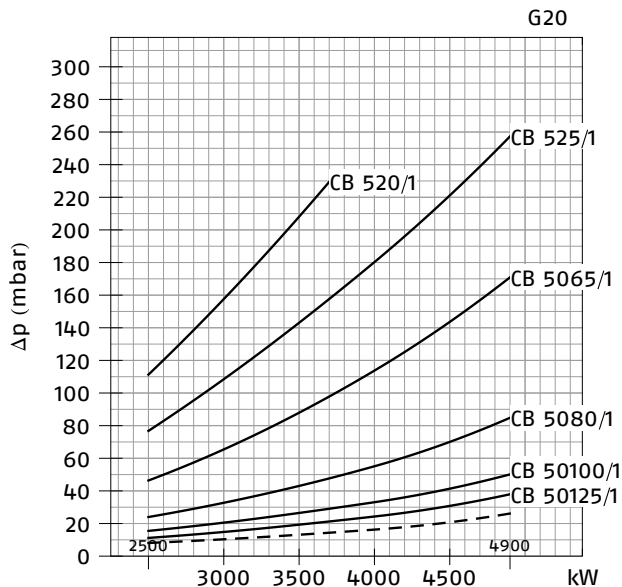

GAS 10 P/M (NATURAL GAS)

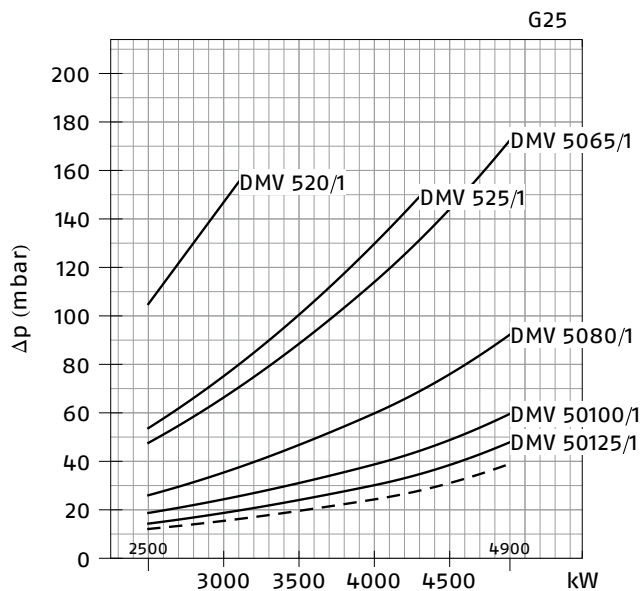
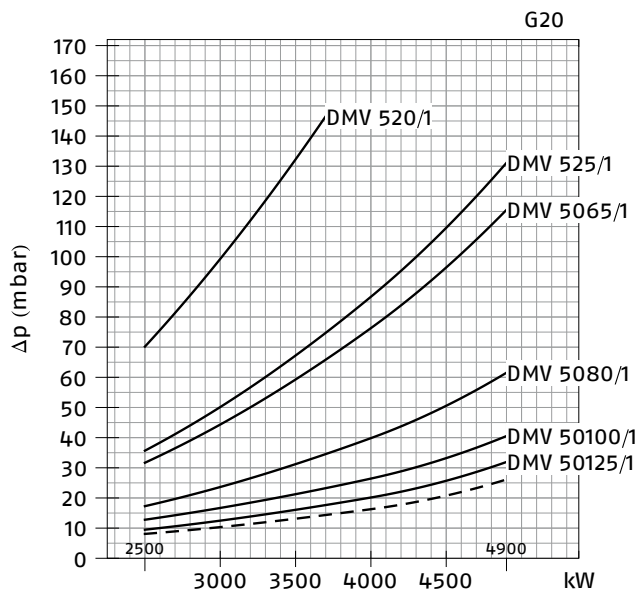

- Combustion head + gas butterfly valve + gas train
- - - Combustion head + gas butterfly valve

Ventilation

The ventilation circuit comes with a forward blades centrifugal fan, which gaurantees high pressure levels at the required air deliveries and permits installation flexibility.
 In spite of the remarkable output power and of the very high pressure performances, GAS P/M models are extremely compact.
 A minimum air pressure switch stops the burner when there is an insufficient quantity of air at the combustion head.
 A variable profile cam connects fuel and air setting, ensuring fuel efficiency at all firing rates.

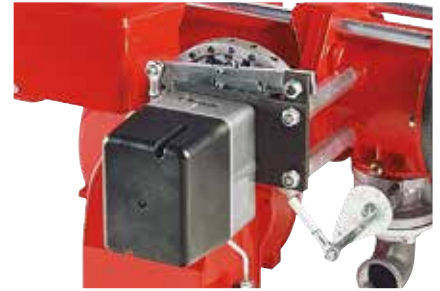

Example of servomotor and air damper of GAS 3 P/M

Combustion Head

Two different combustion head lengths can be selected for the various models of GAS P/M series of burners.
 The choice depends on the thickness of the front panel and type of boiler. Correct head penetration into the combustion chamber depends on the type of heat generator.
 These burners are equipped with a variable geometry combustion head.
 This enables optimum combustion performance throughout the working field, ensuring peak combustion efficiency thus saving on fuel consumption.
 The following diagram shows the flame dimensions in relation to the burner output.
 The lengths and diameter shown in the diagram below should be employed for for a preliminary check: if combustion chamber dimensions are different from the values in the diagram, further tests need to be done.

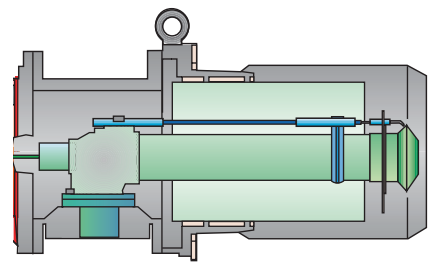

Example of GAS 8 P/M combustion head

DIMENSIONS OF THE FLAME

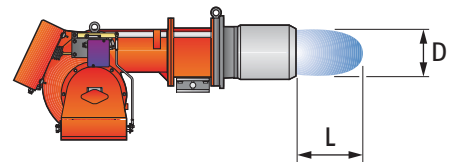
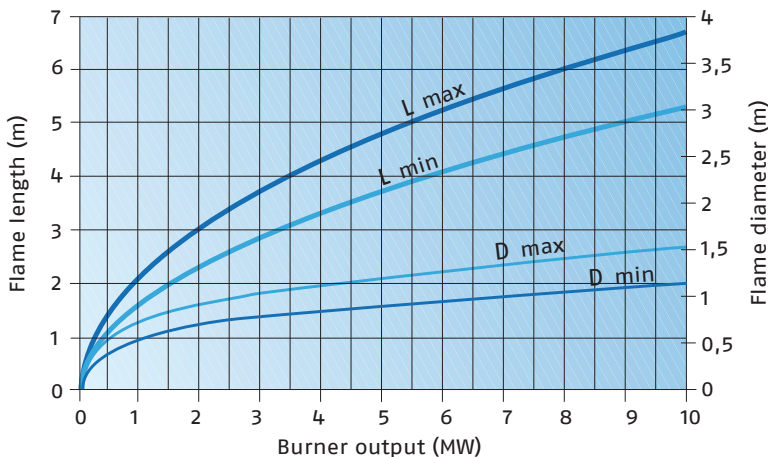

Example:
 Burner thermal output = 3500 kW;
 L flame (m) = 3.5 m (medium value);
 D flame (m) = 1 m (medium value)

Operation

BURNER OPERATION MODE

The GAS P/M series of burners can be "two stage progressive" or "modulating" operation.

During "two stage progressive" operation, the burner gradually adapts the output to the requested level, by varying between two pre-set levels.

During "modulating" operation, normally required in steam generators, in superheated boilers or thermal oil burners, a specific regulator and probes are required.

These are supplied as accessories that must be ordered separately. The burner can work for long periods at intermediate output levels.

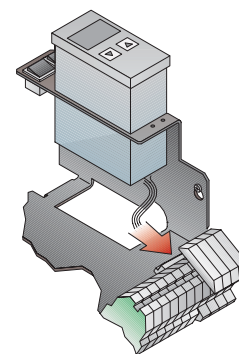

Example of RWF regulator

"Two stage progressive" operation

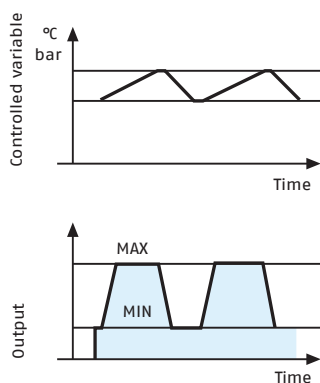

"Modulating" operation

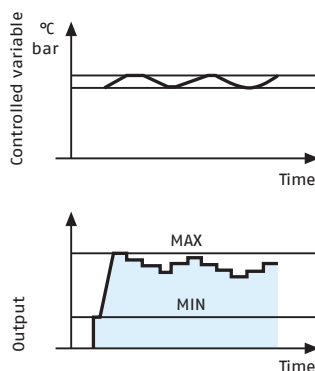

START UP CYCLE

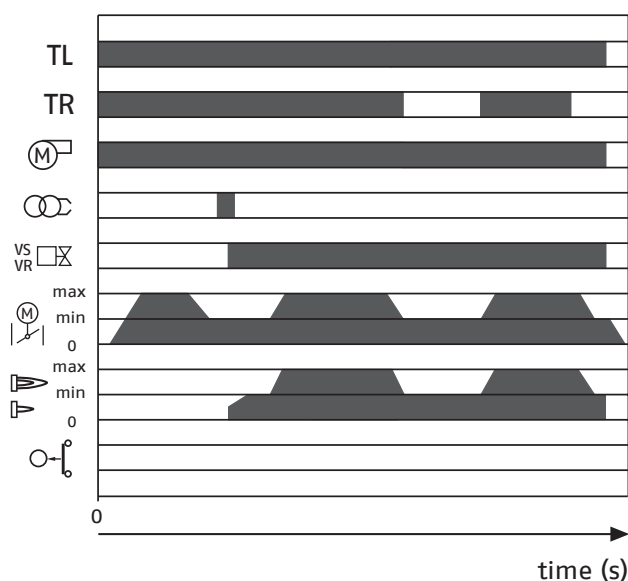

- 0s The burner begins the firing cycle. Load control TL closes and motor starts running.
- 6s - 51s The servomotor opens the air damper at the maximum output.
- 51s - 82s Pre-purge phase with air delivery at maximum output.
- 82s - 117s The servomotor sets the air damper and the butterfly valve at the minimum output.
- 117s - 120s Pre-ignition.
- 126s Firing: all the solenoid gas valves are supplied.
- 126s - 129s After ignition.
- 150s Output can be increased.

Emissions

The emission data has been measured in the various models at maximum output, according to EN 676 standard.

NOx EMISSIONS

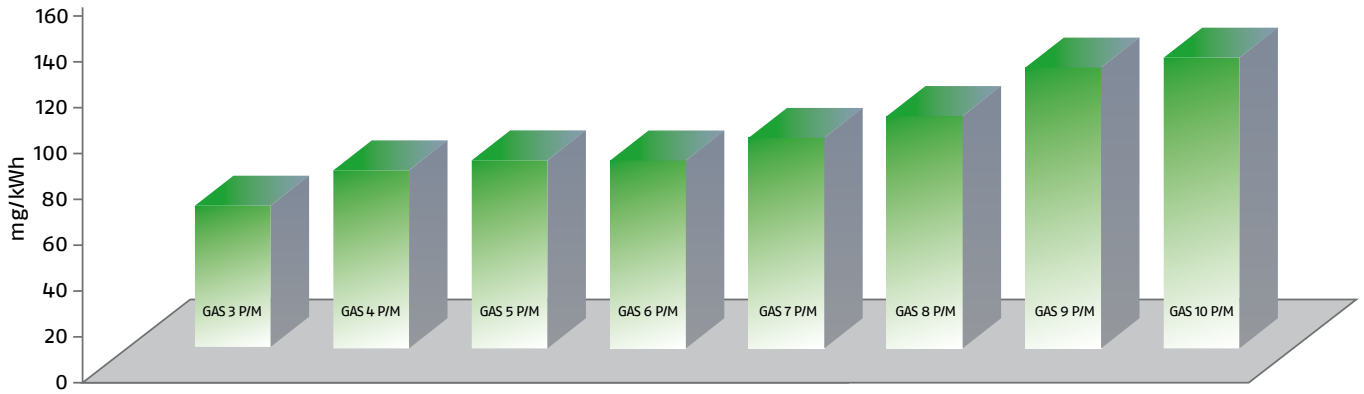

CO EMISSIONS (gas G20)

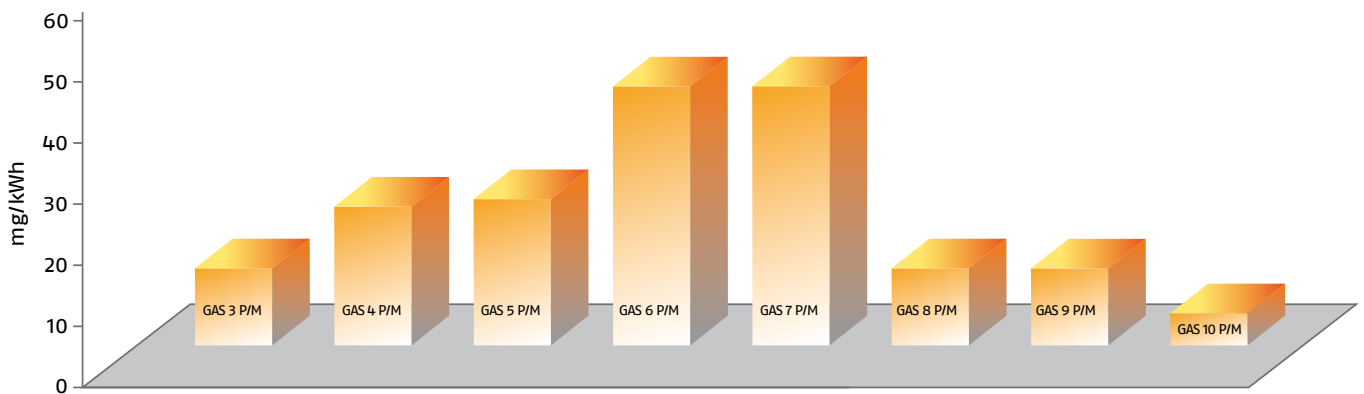

NOISE EMISSIONS

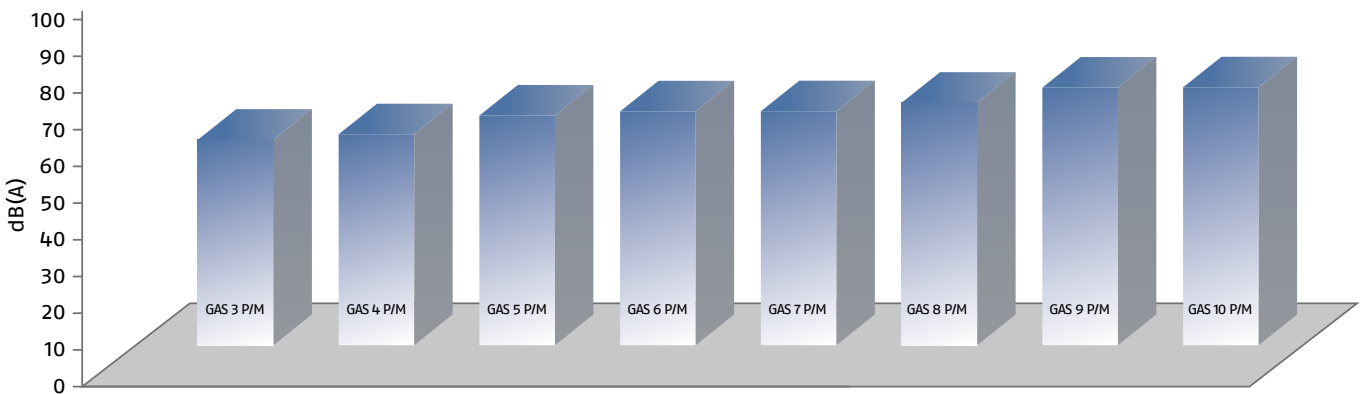

Overall Dimensions (mm)

BURNERS

GAS 3 P/M - 4 P/M - 5 P/M - 6 P/M - 7 P/M

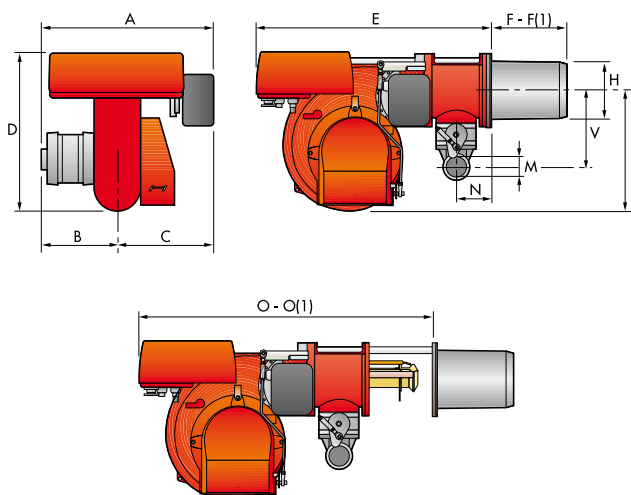

GAS 8 P/M - 9 P/M - 10 P/M

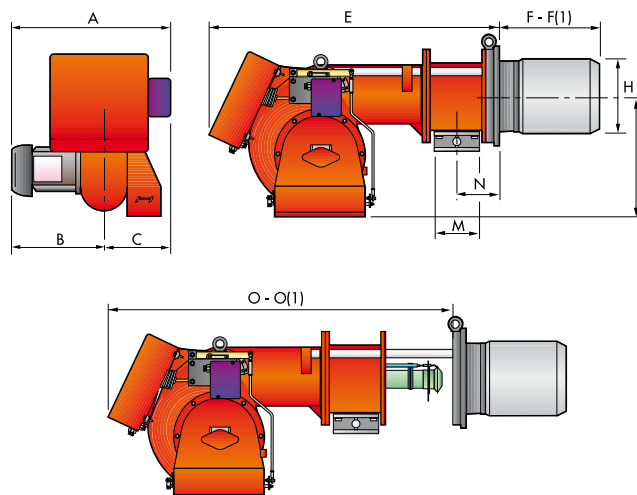

MODEL	A	B	C	D	E	F - F(1)	H	I	M	N	O - O(1)	V
GAS 3 P/M	585	205	380	397	610	185 - 320	140	292	1"1/2	97	775	225
GAS 4 P/M	585	205	380	397	610	187 - 320	150	292	1"1/2	97	775	225
GAS 5 P/M	581	226	355	437	645	207 - 365	155	332	1"1/2	97	810	225
GAS 6 P/M	628	258	370	485	770	227 - 360	175	370	2"	131	966	250
GAS 7 P/M	758	358	400	590	920	240 - 400	220	445	2"	140	1142	305
GAS 8 P/M	755	396	359	-	1090	391 - 501	260	467	DN 80	158	1541 - 1644	-
GAS 9 P/M	817	447	370	-	1200	444 - 574	295	496	DN 80	168	1627 - 1757	-
GAS 10 P/M	917	508	409	-	1320	476 - 606	336	525	DN 80	203	1730 - 1860	-

(1) Length with extended combustion head

BURNER - BOILER MOUNTING FLANGE

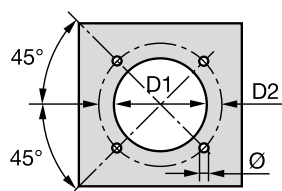

MODEL	D1	D2	Ø
GAS 3 P/M	155	226	M10
GAS 4 P/M	165	226	M10
GAS 5 P/M	165	226	M10
GAS 6 P/M	185	276	M12
GAS 7 P/M	230	325	M12
GAS 8 P/M	265	368	M16
GAS 9 P/M	300	368	M18
GAS 10 P/M	350	438	M20

PACKAGING

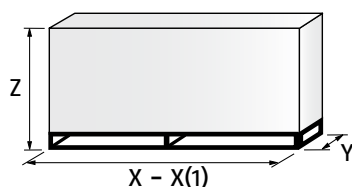

MODEL	X - X(1)	Y	Z	kg
GAS 3 P/M	930	705	555	37
GAS 4 P/M	930	705	555	43
GAS 5 P/M	930	705	555	46
GAS 6 P/M	1045	705	555	63
GAS 7 P/M	1400	850	650	101
GAS 8 P/M	1740	990	950	195
GAS 9 P/M	2040	1180	1125	240
GAS 10 P/M	2040	1180	1125	310

Installation Description

Installation, start up and maintenance must be carried out by qualified and skilled personnel. All operations must be performed in accordance with the technical handbook supplied with the burner.

BURNER SETTING

- All the burners have slide bars, for easier installation and maintenance.
- After drilling the boilerplate, using the supplied gasket as a template, dismantle the blast tube from the burner and fix it to the boiler.
- Adjust the combustion head.
- Fit the gas train, choosing this on the basis of the maximum output of the boiler and considering the enclosed diagrams.
- Refit the burner casing to the slide bars.
- Close the burner, sliding it up to the flange.

ELECTRICAL CONNECTIONS AND START UP

- Make the electrical connections to the boiler following the wiring diagrams included in the instruction handbook.
- Turn the motor to check rotation direction (if it is a three-phase motor).
- Perform a first ignition calibration on the gas train.
- On start up, check:
 - Gas pressure at the combustion head (to max. and min. output)
 - Combustion quality, in terms of unburned substances and excess air.

Burner Accessories

Extended head kit

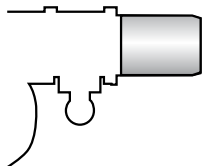

“Standard head” burners can be transformed into “extended head” versions, by using the special kit.

MODEL	STANDARD HEAD LENGTH (mm)	EXTENDED HEAD LENGTH (mm)	KIT CODE
GAS 3 P/M	185	320	3000605
GAS 4 P/M	187	320	3000606
GAS 5 P/M	207	365	3000607
GAS 6 P/M	227	360	3000608
GAS 7 P/M	240	400	3000678

Spacer kit



If burner head penetration into the combustion chamber needs reducing, varying thickness spacers are available, as given in the following list.

MODEL	SPACER THICKNESS S (mm)	KIT CODE
GAS 3 - 4 - 5 - 6 P/M	142	3000755
GAS 7 - 8 P/M	102	3000722
GAS 9 P/M	130	3000723
GAS 10 P/M	130	3000751

Continuous ventilation kit



If the burner requires continuous ventilation in the stages without flame, a special kit is available as given in the following table.

MODEL	KIT CODE
GAS 3 - 4 - 5 - 6 - 7 P/M	3010030

Burner support

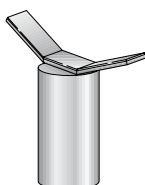

For easier maintenance, a mobile burner support has been designed, which means the burner can be dismantled without the need of forklift trucks.

MODEL	KIT CODE
GAS 8 P/M - GAS 10 P/M	3000731

Sound proofing box

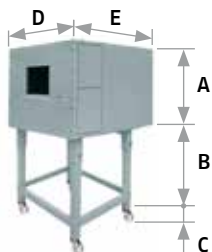

If noise emission needs reducing even further, sound-proofing boxes are available. In case of generator heights, where a lower dimension "B" is required, ask for the Box Support Kit code 20065135. The useful dimensions are 40 mm less than the total dimensions indicated in the table (A, D, E). Not suitable for outdoor use.

MODEL	BOX TYPE	A (mm)	B (mm) min-max	C (mm)	D (mm)	E (mm)	[dB(A)] (*)	KIT CODE
GAS 3 - 4 - 5 - 6 P/M	C1/3	650	372-980	110	690	770	10	3010403
GAS 7 - 8 P/M	C4/5	850	160-980	110	980	930	10	3010404
GAS 10 P/M	C7	1255	160-980	110	1140	1345	10	3010376

(*) Average noise reduction according to EN 15036-1 standard

LPG kit

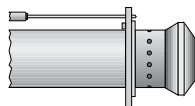

For burning LPG gas, a special kit is available.

MODEL	KIT CODE FOR STANDARD HEAD	KIT CODE FOR EXTENDED HEAD
GAS 3 P/M	3000657	3000807
GAS 4 P/M	3000658	3000808
GAS 5 P/M	3000659	3000809
GAS 6 P/M	3000753	3000810
GAS 7 P/M	3000806	3000811
GAS 8 P/M	3000875	3010029
GAS 9 P/M	3000876	3010028
GAS 10 P/M	3010152	3010153

Town gas kit

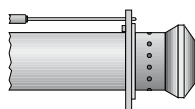

For burning Town Gas, a special kit is available.

MODEL	KIT CODE FOR STANDARD HEAD	KIT CODE FOR EXTENDED HEAD (*)
GAS 3 P/M	3000742	-
GAS 4 P/M	3000754	-
GAS 5 P/M	3000759	-
GAS 6 P/M	3000768	-
GAS 7 P/M	3000769	-
GAS 8 P/M	-	-
GAS 9 P/M	3010298	3010298
GAS 10 P/M	3010300	3010300

(*) Without CE certification

Butane Gas kit

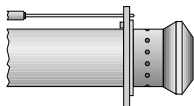

For burning Butane Gas ($C_3H_8 = 25\% - C_4H_{10} = 75\%$), a special kit is available.

MODEL	KIT CODE FOR STANDARD HEAD	KIT CODE FOR EXTENDED HEAD (*)
GAS 8 P/M	20013604	20013673
GAS 9 P/M	20012268	20013674
GAS 10 P/M	20012270	20013675

(*) Without CE certification

Accessories for modulating operation



To obtain modulating operation, the GAS P/M series of burners requires a regulator.

MODEL	REGULATOR TYPE	REGULATOR CODE
GAS 3 - 4 - 5 - 6 - 7 P/M	RWF 50.2	20105445
	RWF 55.5	20105717
GAS 8 - 9 - 10 P/M	RWF 50.2	20100018
	RWF 55.5	20101965



The relative temperature or pressure probes fitted to the regulator, must be chosen on the basis of the application.

MODEL	PROBE TYPE	RANGE (°C) (bar)	PROBE CODE
GAS 3 - 4 - 5 - 6 - 7 P/M	Temperature PT 100	-100 ÷ 500°C	3010110
	Pressure 4 ÷ 20 mA	0 ÷ 2,5 bar	3010213
GAS 8 - 9 - 10 P/M	Pressure 4 ÷ 20 mA	0 ÷ 16 bar	3010214
	Pressure 4 ÷ 20 mA	0 ÷ 25 bar	3090873















Depending on the servomotor fitted to the burner, a three-pole potentiometer (1000 Ω) can be installed to check the position of the servomotor.

MODEL	POTENTIOMETER KIT CODE
GAS 3 - 4 - 5 - 6 - 7 - 8 - 9 - 10 P/M	3010021

Gas Train Accessories

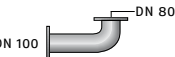
Adapters

In certain cases, an adapter must be fitted between the gas train and the burner, when the diameter of the gas train is different from the set diameter of the burner. Below are given the available adapters; please see on the Gas Train list the correct adapter codes to select.

ADAPTER	LENGTH (mm)	ADAPTER CODE
2"  1" 1/2	70	3000822
3/4"  1" 1/2	31	3000824
DN 65  2" 1/2  2"	300	3000825
DN 80  2" 1/2  1" 1/2	300	3000826
1" 1/2  2"	35	3000843
DN 65  DN 80	320	3000831
DN 80  DN 80	320	3000832
DN 100  DN 80	320	3010127
2"  2"	58	3010495
1" 1/4  1" 1/2	35	3010124
1" 1/4  2"	35	3010126

Seal control kit



To test the valve seals on the gas train, a special "seal control kit" is available.

GAS TRAIN	KIT CODE for 50 Hz operation	KIT CODE for 60 Hz operation
MB/1 type	3010123	20029057
MBC/1 type	3010367	20029057
CB/1 type	3010367	20029057

Stabiliser spring



Accessory springs are available to vary the pressure range of the gas train stabilisers.

GAS TRAIN	SPRING COLOUR	SPRING PRESSURE RANGE mbar	SPRING CODE
MBC 1900/1 - 3100/1 MBC 5000/1	White	4 - 20	3010381
	Red	20 - 40	3010382
	Black	40 - 80	3010383
	Green	80 - 150	3010384
CB 512/1	Red	25 - 55	3010131
	Black	60 - 110	3010157
	Pink	90 - 150	3090486
CB 520/1 - 525/1	Red	25 - 55	3010132
	Black	60 - 110	3010158
	Pink	100 - 150	3090487
CB 5065/1 - 5080/1	Red	25 - 55	3010133
	Black	60 - 110	3010135
	Pink	100 - 150	3090456
	Grey	140 - 200	3090992
CB 50100/1	Red	25 - 55	3010134
	Black	60 - 110	3010136
	Pink	100 - 150	3090489
	Grey	140 - 200	3092174

Specification

DESIGNATION OF SERIES

A specific index guides your choice of burner from the various models available in the GAS series. Below is a clear and detailed specification description of the product.

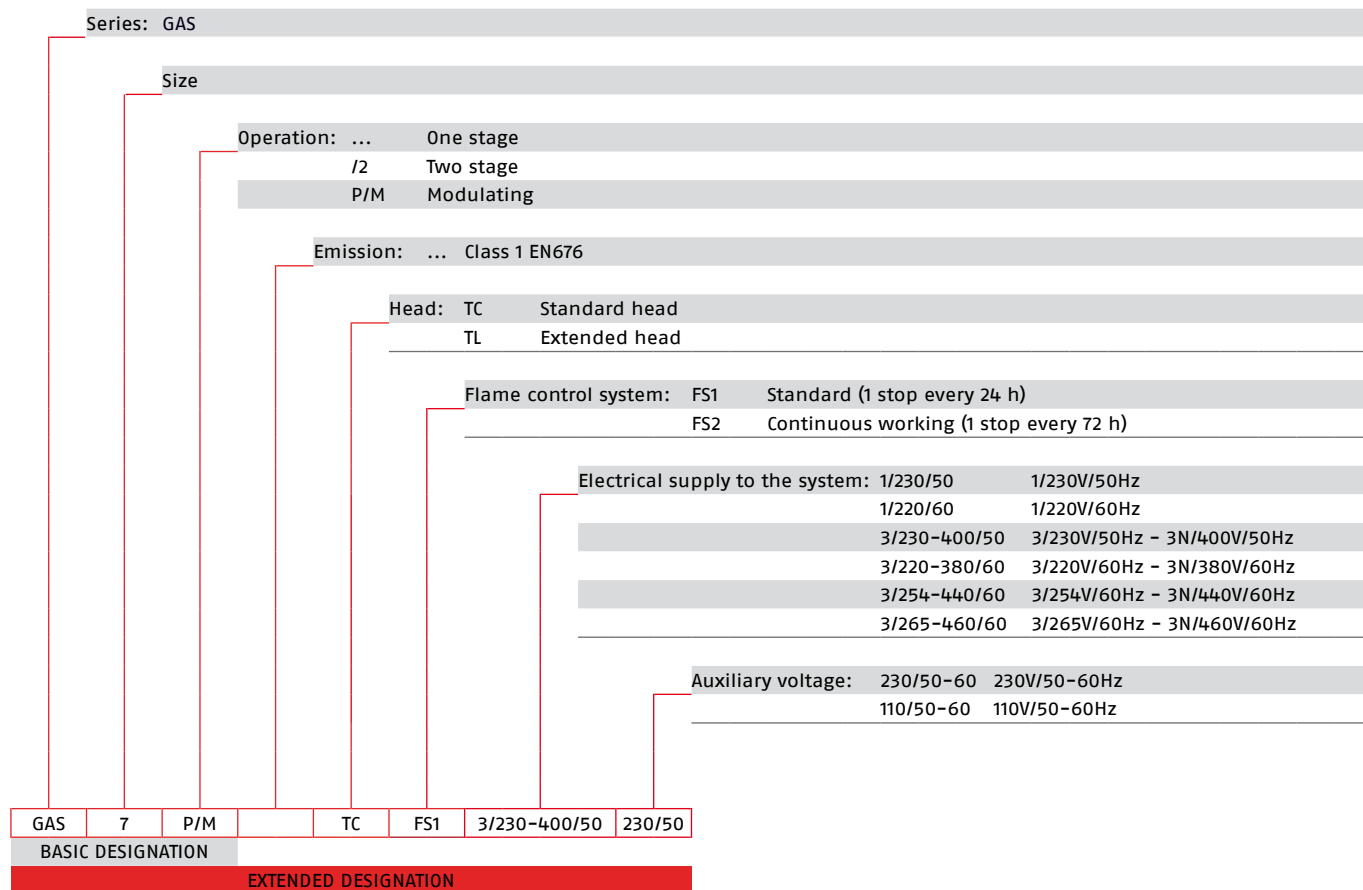

AVAILABLE BURNER MODELS

BURNER MODELS		ELECTRICAL SUPPLY		HEAT OUTPUT		TOTAL ELECTRICAL POWER (kW)	CERTIFICATION	NOTE
				NATURAL GAS				
				(kW)	(Nm ³ /h)			
GAS 3 P/M	TC	FS1	1/210/60	120/50-60	80/130-340	8/13-34	0,4	-
GAS 3 P/M	TC	FS1	1/230/50	230/50-60	80/130-350	8/13-35	0,4	CE 0085AQ0710
GAS 4 P/M	TC	FS1	1/230/50	230/50-60	120/180-470	12/18-47	0,54	CE 0085AQ0710
GAS 4 P/M	TC	FS1	3/210/60	120/50-60	115/180-470	11,5/18-47	0,54	-
GAS 4 P/M	TC	FS1	3/220-380/60	220/60	115/180-470	11,5/18-47	0,6	-
GAS 5 P/M	TC	FS1	3/210/60	120/50-60	155/320-660	15,5/32-66	0,85	-
GAS 5 P/M	TC	FS1	3/220-380/60	220/60	155/320-660	15,5/32-66	0,85	-
GAS 5 P/M	TC	FS1	3/230-400/50	230/50-60	155/320-660	15,5/32-66	0,85	CE 0085AQ0710
GAS 6 P/M	TC	FS1	3/210/60	120/50-60	300/520-1050	30/52-105	1,9	-
GAS 6 P/M	TC	FS1	3/220-380/60	220/60	300/520-1050	30/52-105	1,9	-
GAS 6 P/M	TC	FS1	3/230-400/50	230/50-60	300/520-1050	30/52-105	1,9	CE 0085AQ0710
GAS 7 P/M	TC	FS1	3/210/60	120/50-60	400/800-1760	40/80-176	4,5	-
GAS 7 P/M	TC	FS1	3/220-380/60	220/60	400/800-1760	40/80-176	4,5	-
GAS 7 P/M	TC	FS1	3/230-400/50	230/50-60	400/800-1760	40/80-176	4,5	CE 0085AQ0710
GAS 8 P/M	TC	FS1	3/220-380/60	220/60	580/1163-2325	58/116-232,5	5	-
GAS 8 P/M	TC	FS1	3/230-400/50	230/50	640/1163-2210	64/116-221	5	CE 0085AP0941
GAS 8 P/M	TC	FS1	3/230-400/50	230/50-60	640/1163-2210	64/116-221	5	CE 0085AP0941
GAS 8 P/M	TL	FS1	3/220-380/60	220/60	580/1163-2325	58/116-232,5	5	-
GAS 8 P/M	TL	FS1	3/230-400/50	230/50	640/1163-2210	64/116-221	5	CE 0085AP0941
GAS 8 P/M	TL	FS1	3/230-400/50	230/50-60	640/1163-2210	64/116-221	5	CE 0085AP0941
GAS 9 P/M	TC	FS1	3/220-380/60	220/60	870/1744-3488	87/174-349	16,9	-
GAS 9 P/M	TC	FS1	3/230/50	230/50	870/1744-3488	87/174-349	16,9	CE 0085AP0942 (1) (2)
GAS 9 P/M	TC	FS1	3/230/50	230/50-60	870/1744-3488	87/174-349	16,9	CE 0085AP0942 (1)
GAS 9 P/M	TC	FS1	3/230-400/50	230/50	870/1744-3488	87/174-349	16,9	CE 0085AP0942 (2)
GAS 9 P/M	TC	FS1	3/230-400/50	230/50-60	870/1744-3488	87/174-349	16,9	CE 0085AP0942
GAS 9 P/M	TC	FS1	3/400/50	230/50	870/1744-3488	87/174-349	16,9	CE 0085AP0942 (1) (2)
GAS 9 P/M	TC	FS1	3/400/50	230/50-60	870/1744-3488	87/174-349	16,9	CE 0085AP0942 (1)
GAS 9 P/M	TL	FS1	3/220-380/60	220/60	870/1744-3488	87/174-349	16,9	-
GAS 9 P/M	TL	FS1	3/230/50	230/50	870/1744-3488	87/174-349	16,9	CE 0085AP0942 (1) (2)
GAS 9 P/M	TL	FS1	3/230/50	230/50-60	870/1744-3488	87/174-349	16,9	CE 0085AP0942 (1)
GAS 9 P/M	TL	FS1	3/230-400/50	230/50	870/1744-3488	87/174-349	16,9	CE 0085AP0942 (2)
GAS 9 P/M	TL	FS1	3/230-400/50	230/50-60	870/1744-3488	87/174-349	16,9	CE 0085AP0942
GAS 9 P/M	TL	FS1	3/400/50	230/50	870/1744-3488	87/174-349	16,9	CE 0085AP0942 (1) (2)
GAS 9 P/M	TL	FS1	3/400/50	230/50-60	870/1744-3488	87/174-349	16,9	CE 0085AP0942 (1)
GAS 10 P/M	TC	FS1	3/220/60	220/60	1140/2441-5000	114/244-500	16,9	- (1)
GAS 10 P/M	TC	FS1	3/230/50	230/50	1140/2441-4885	114/244-489	16,9	CE 0085AP0943 (1) (2)
GAS 10 P/M	TC	FS1	3/230/50	230/50-60	1140/2441-4885	114/244-489	16,9	CE 0085AP0943 (1)
GAS 10 P/M	TC	FS1	3/380/60	220/60	1140/2441-5000	114/244-500	16,9	- (1)
GAS 10 P/M	TC	FS1	3/400/50	230/50	1140/2441-4885	114/244-489	16,9	CE 0085AP0943 (1) (2)
GAS 10 P/M	TC	FS1	3/400/50	230/50-60	1140/2441-4885	114/244-489	16,9	CE 0085AP0943 (1)
GAS 10 P/M	TL	FS1	3/220/60	220/60	1140/2441-5000	114/244-500	16,9	- (1)
GAS 10 P/M	TL	FS1	3/230/50	230/50	1140/2441-4885	114/244-489	16,9	CE 0085AP0943 (1) (2)
GAS 10 P/M	TL	FS1	3/230/50	230/50-60	1140/2441-4885	114/244-489	16,9	CE 0085AP0943 (1)
GAS 10 P/M	TL	FS1	3/380/60	220/60	1140/2441-5000	114/244-500	16,9	- (1)
GAS 10 P/M	TL	FS1	3/400/50	230/50	1140/2441-4885	114/244-489	16,9	CE 0085AP0943 (1) (2)
GAS 10 P/M	TL	FS1	3/400/50	230/50-60	1140/2441-4885	114/244-489	16,9	CE 0085AP0943 (1)

(1) Star delta starter

(2) With ground fault interrupter kit

 Natural gas G20 net calorific value: 10 kWh/Nm³ - Density gas G20: 0,71 kg/Nm³

The burners of GAS P/M series are in according to 2006/42/EC - 2009/142/EC - 2014/30/UE - 2014/35/UE Directive and EN 676 Norm.

PRODUCT SPECIFICATION

Burner

Monoblock forced draught gas burner, two stage progressive operation or modulating with a kit, made up of:

- Air suction circuit
- Fan with forward curved blades
- Air damper for air setting controlled by a servomotor;
- Combustion head, that can be set on the basis of required output, fitted with:
 - stainless steel end cone, resistant to corrosion and high temperatures
 - ignition electrodes
 - flame stability disk
- Servomotor for air and gas delivery regulation
- Maximum gas pressure switch (except for GAS 3 P/M model and GAS 6 P/M code 3753681)
- Minimum air pressure switch
- Single phase or three phases electrical motor
- Ionisation probe
- Flame inspection window
- Slide bars for easier installation and maintenance
- Protection filter against radio interference
- IP X0D (IP 40) protection level.

Gas train

Fuel supply line, in the MULTIBLOC configuration (from a diameter of 3/4" until a diameter 2") or COMPOSED configuration (from a diameter of DN 65 until a diameter of DN 100), fitted with:

- Filter
- Stabiliser
- Minimum gas pressure switch
- Safety valve
- Valve seal control (for output > 1200 kW)
- One stage working valve with ignition gas output regulator.

Standard equipment:

- 1 gas train flange
- 1 flange gasket
- 1 insulating screen
- 8 screws for fixing the burner flange to the boiler (12 for GAS 8 P/M - GAS 9 P/M and GAS 10 P/M)
- 4 wiring looms for electrical connections
- 1 star delta starter (for GAS 8 P/M - GAS 9 P/M and GAS 10 P/M)
- 2 wiring looms for electrical connections to the star delta starter (for GAS 8 P/M - GAS 9 P/M and GAS 10 P/M)
- 8 washers (for GAS 8 P/M - GAS 9 P/M and GAS 10 P/M)
- 2 bar extensions (only for extended head versions of GAS 8 P/M - GAS 9 P/M and GAS 10 P/M)
- Instruction handbook for installation, use and maintenance
- Spare parts catalogue.

Conforming to:

- 2014/30 UE Directive (electromagnetic compatibility)
- 2014/35 UE Directive (low voltage)
- 2009/142 EC Directive (gas)
- 2006/42 EC Directive (machine)
- EN 676 (gas burners)

Available accessories to be ordered separately

- Extended head kit
- Spacer kit
- Continuous ventilation kit
- Burner support
- Sound-proofing box
- LPG kit
- Town gas kit
- Butane gas kit
- Gas train adapter
- Seal control kit
- Stabiliser spring

Riello Burners a world of experience in every burner we sell.

05/2016

TS0049UK02



[1]

Across the world, Riello sets the standard in reliable and high efficiency burner technology.

With burner capacity from 5 kW to 48 MW, Riello gas, oil, dual fuel and Low Nox burners deliver unbeatable performance across the full range of residential and commercial heating applications, as well as in industrial processes.

With headquarter in Legnago, Italy, Riello has been manufacturing premium quality burners for over 90 year. The manufacturing plant is equipped with the most innovative systems of assembling lines and modern manufacturing cells for a quick and flexible response to the market.



[2]

Besides, the Riello Combustion Research Centre, located in Angiari, Italy, represents one of the most modern facility in Europe and one of the most advanced in the world for the development of the combustion technology.

Today, the company's presence on worldwide markets is distinguished by a well-constructed and efficient sales network, alongside many important Training Centres located in various countries to meet its customers' needs. Riello has 13 operational branches abroad (in Europe, America and Asia), with customers in over 60 countries.

[1] BURNERS PRODUCTION PLANT
S. PIETRO, LEGNAGO (VERONA) - ITALIA

[2] HEADQUARTER BURNERS DIVISION
S. PIETRO, LEGNAGO (VERONA) - ITALIA

RIELLO S.p.A. - 37045 Legnago (VR) - Italy
tel. +39 0442 630111 - fax: +39 0442 21980
www.riello.com

Since the Company is constantly engaged in the production improvement, the aesthetic and dimensional features, the technical data, the equipment and the accessories can be changed. This document contains confidential and proprietary information of RIELLO S.p.A. Unless authorised, this information shall not be divulged, nor duplicated in whole or in part.

RIELLO